

# JVC



## MICRO COMPONENT MD SYSTEM

MD 微型组合音响

**UX-F70MD** — Consists of CA-UXF70MD and SP-UXF70MD

**UX-F72MD** — Consists of CA-UXF72MD and SP-UXF72MD

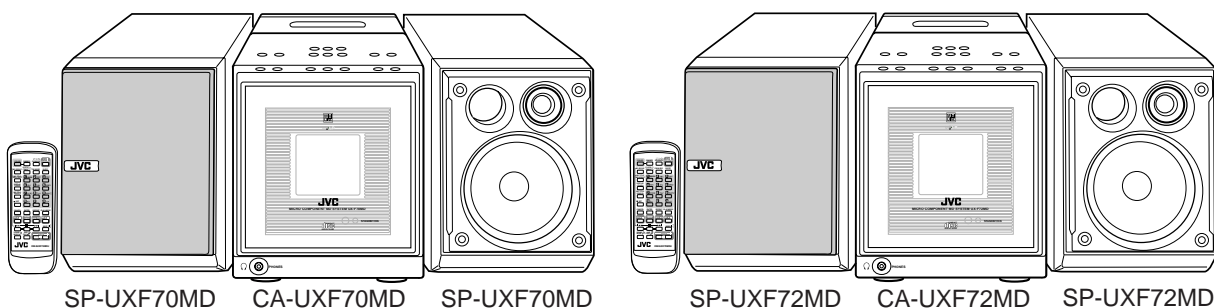

COMPACT  
**disc**  
DIGITAL AUDIO



**MDLP**

### INSTRUCTIONS 使用说明书

**For Customer Use:**

Enter below the Model No. and Serial No. which are located either on the rear, bottom or side of the cabinet. Retain this information for future reference.

Model No. \_\_\_\_\_

Serial No. \_\_\_\_\_

## Warnings, Cautions and Others

### 警告，注意及其他须知事项

---

#### **Caution — STANDBY/ON button!**

Disconnect the mains plug to shut the power off completely (the STANDBY/ON lamp goes off).

The  STANDBY/ON button in any position does not disconnect the mains line.

- When the unit is on standby, the STANDBY/ON lamp lights red.
- When the unit is turned on, the STANDBY/ON lamp lights green.

The power can be remote controlled.

#### **注意— STANDBY/ON 开关！**

无论  STANDBY/ON 开关在任何位置，电源线的电源还是没有被切断，若要将电源完全关闭，应把电源插头拨离插座，（STANDBY/ON 灯熄灭）。

- 当主机正处于备用状态，STANDBY/ON 灯为红色。
- 当主机开启后，STANDBY/ON 灯为青色。

电源开关可用遥控器控制。

**CAUTION**

To reduce the risk of electrical shocks, fire, etc.:

1. Do not remove screws, covers or cabinet.
2. Do not expose this appliance to rain or moisture.

**CAUTION**

- Do not block the ventilation openings or holes. (If the ventilation openings or holes are blocked by a newspaper or cloth, etc., the heat may not be able to get out.)
- Do not place any naked flame sources, such as lighted candles, on the apparatus.
- When discarding batteries, environmental problems must be considered and local rules or laws governing the disposal of these batteries must be followed strictly.
- Do not use this apparatus in a bathroom or places with water. Also do not place any containers filled with water or liquids (such as cosmetics or medicines, flower vases, potted plants, cups, etc.) on top of this apparatus.

**警告**

为了减低触电，火灾等危险：

1. 请勿擅自卸下螺丝钉，盖子或机壳。
2. 切勿让本机受雨淋或置潮湿环境中。

**注意**

- 请勿堵塞通风口或通风孔。  
(如果通风口或通风孔被报纸或布等堵塞，热量将无法散出。)
- 请勿在本设备上放置任何裸露的火源，如点燃的蜡烛。
- 处理废弃电池时，必须考虑环境问题，并严格遵守当地关于处理废弃电池的有关法律或规定。
- 请勿在浴室里或有水汽的地方使用本设备。亦请勿在本设备的上方放置任何装有水或液体的容器（如化妆品，药品，花瓶，花盆，杯子等）。

### Caution: Proper Ventilation

To avoid risk of electric shock and fire, and to prevent damage, locate the apparatus as follows:

- 1 Front: No obstructions and open spacing.
- 2 Sides/ Top/ Back: No obstructions should be placed in the areas shown by the dimensions below.
- 3 Bottom: Place on the level surface. Maintain an adequate air path for ventilation by placing on a stand with a height of 10 cm or more.

### 注意：正确通风

为免发生触电和火警的危险，及防止本机受损，请将本机如下放置：

1. 前面：没有障碍物及地方开阔。
2. 侧面/顶部/背面：在图中所示范围中，不应放置任何障碍物。
3. 底部：放置在水平面上。放置在一个高 10 厘米或以上的台上，以保持足够的通风道。

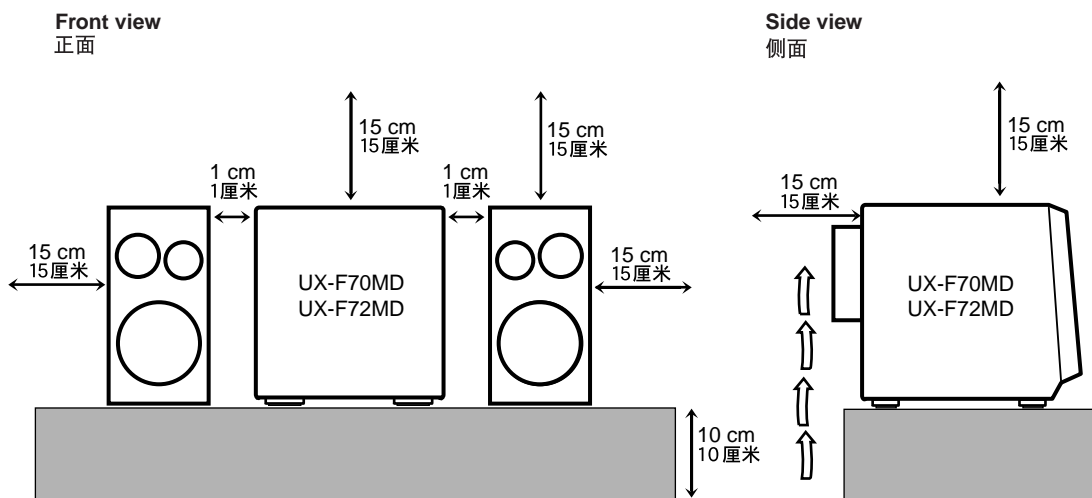

## IMPORTANT FOR LASER PRODUCTS / 雷射产品的重要说明

### REPRODUCTION OF LABELS / 标签内容说明

① CLASSIFICATION LABEL, PLACED ON REAR ENCLOSURE

② WARNING LABEL, PLACED INSIDE THE UNIT

① 分类标签，贴在机壳背后

② 警告标签，贴于机内

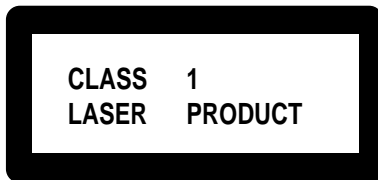

**DANGER:** Invisible laser radiation when open and interlock failed or defeated. AVOID DIRECT EXPOSURE TO BEAM. (e)

**WARNING:** Osynlig laserstrålning när denna del är öppnad och spärren är urkopplad. Beträkta ej strålen. (s)

**ADVARSEL:** Usynlig laserstrålning ved åbning, når sikkerhedsafbrydere er ude af funktion. Undgå udsættelse for stråling (d)

**VARO:** Avattaessa ja suojalukitus ohitettaessa olet allittina näkymättömälle lasersäteilylle. Älä katso säteeseen. (f)

1. CLASS 1 LASER PRODUCT
2. **DANGER:** Invisible laser radiation when open and interlock failed or defeated. Avoid direct exposure to beam.
3. **CAUTION:** Do not open the top cover. There are no user serviceable parts inside the unit; leave all servicing to qualified service personnel.

1. 一级雷射产品
2. **危险：**当内部锁定装置失效或者损坏后，打开盖板可能会产生不可见的雷射辐射。应避免受到光束直接照射。
3. **注意：**请勿打开顶盖板。本机内部没有用户可自行维修的部件；所有维修工作应由有资格的人员完成。



# Introduction

We would like to thank you for purchasing one of our JVC products. Before operating this unit, read this manual carefully and thoroughly to obtain the best possible performance from your unit, and retain this manual for future reference.

## About This Manual

This manual is organized as follows:

- This manual mainly explains playback and editing operations using the remote control, and the other operations such as recording operations using the buttons on the main unit. You can use the buttons both on the remote control and on the main unit for the same operations if they have the same or similar names (or marks), unless mentioned otherwise.
- Basic and common information that is the same for many functions is grouped in one place, and is not repeated in each procedure. For instance, we do not repeat the information about turning on/off the unit, setting the volume, changing the sound effects, and others, which are explained in the section “Basic and Common Operations” on pages 10 – 13.
- The following marks are used in this manual:

	<p>Gives you warning and caution to prevent from damage or risk of fire/electric shock. Furthermore, gives you information which is not good for obtaining the best possible performance from the unit.</p>
	<p>Gives you information and hints you had better know.</p>

## Precautions

### Installation

- Install in a place which is level, dry and neither too hot nor too cold — between 5°C (41°F) and 35°C (95°F).
- Install the unit in a location with adequate ventilation to prevent internal heat buildup in the unit.
- Leave sufficient distance between the unit and the TV.
- Keep the speakers away from the TV to avoid interference with TV.



DO NOT install the unit in a location near heat sources, or in a place subject to direct sunlight, excessive dust or vibration.

### Power sources

- When unplugging the unit from the wall outlet, always pull the plug, not the AC power cord.



DO NOT handle the AC power cord with wet hands.

### Moisture condensation

Moisture may condense on the lens inside the unit in the following cases:

- After starting heating in the room
  - In a damp room
  - If the unit is brought directly from a cold to a warm place
- Should this occur, the unit may malfunction. In this case, leave the unit turned on for a few hours until the moisture evaporates, unplug the AC power cord, then plug it in again.

### Others

- Should any metallic object or liquid fall into the unit, unplug the AC power cord and consult your dealer before operating any further.
- If you are not going to operate the unit for an extended period of time, unplug the AC power cord from the wall outlet.



DO NOT disassemble the unit since there are no user serviceable parts inside.

If anything goes wrong, unplug the AC power cord and consult your dealer.

# Contents

<b>Location of the Buttons</b> .....	<b>3</b>	<b>Recording on Tapes</b> .....	<b>35</b>
Main Unit .....	3	Before You Start Recording on a Tape .....	36
Remote Control .....	5	Recording FM/AM Broadcasts .....	37
<b>Getting Started</b> .....	<b>6</b>	Recording CD — CD Synchronized Recording ....	37
Unpacking .....	6	Recording MD — MD Synchronized Recording ..	38
Connecting Antennas .....	6	Recording the External Equipment .....	38
Connecting Speakers .....	7	Recording CD onto an MD and a Tape	
Connecting Other Equipment .....	8	— CD Synchronized Recording .....	39
Putting the Batteries into the Remote Control .....	9	<b>Editing MD Groups</b> .....	<b>40</b>
<b>Basic and Common Operations</b> .....	<b>10</b>	Guidance — MD Group Functions .....	41
Turning On the Power .....	11	Introducing MD Group Editing .....	42
Selecting the Sources and Starting Play .....	11	Forming a Group — FORM GR .....	43
Adjusting the Volume .....	12	Adding a Track to a Group — ENTRY GR .....	44
Turning On/Off the Key-touch Tone .....	12	Dividing a Group — DIVIDE GR .....	44
Reinforcing the Bass Sound .....	12	Joining Two Groups — JOIN GR .....	45
Selecting the Sound Modes .....	12	Moving a Group — MOVE GR .....	46
Setting the Display Illumination .....	13	Ungrouping Tracks — UNGROUP .....	46
<b>Listening to FM and AM Broadcasts</b> .....	<b>14</b>	Dissolving All Groups — UNGR ALL .....	47
Setting the AM Tuner Interval Spacing .....	15	Erasing Tracks in a Group — ERASE GR .....	47
Tuning in a Station .....	15	<b>Editing MD Tracks</b> .....	<b>48</b>
Presetting Stations .....	15	Introducing MD Track Editing .....	49
Tuning in a Preset Station .....	16	Dividing a Track — DIVIDE .....	50
<b>Playing Back a CD</b> .....	<b>17</b>	Joining Two Tracks — JOIN .....	50
Precautions on CD Playback .....	18	Moving a Track — MOVE .....	51
Playing Back the Entire CD — Normal Play .....	18	Erasing Tracks — ERASE .....	52
Basic CD Operations .....	19	Erasing All Tracks — ALL ERASE .....	52
Programing the Playing Order of the Tracks		<b>Assigning Titles to an MD</b> .....	<b>53</b>
— Program Play .....	19	Assigning the Disc Title, Track Title	
Playing at Random — Random Play .....	20	and Group Title .....	54
Repeating Tracks — Repeat Play .....	21	<b>Using the Timers</b> .....	<b>56</b>
<b>Playing Back an MD</b> .....	<b>22</b>	Setting the Clock .....	57
Playing Back the Entire MD — Normal Play .....	23	Using Recording Timer .....	57
Basic MD Operations .....	24	Using Daily Timer .....	58
Programing the Playing Order of the Tracks		Using Sleep Timer .....	60
— Program Play .....	24	Timer Priority .....	60
Playing at Random — Random Play .....	25	<b>Maintenance</b> .....	<b>61</b>
Playing Tracks in a Group — Group Play .....	25	<b>Additional Information</b> .....	<b>62</b>
Repeating Tracks — Repeat Play .....	26	MD Disc Types .....	62
Searching by Title of the Track		ATRAC (Adaptive TRansform Acoustic Coding)/	
— MD Title Search .....	26	ATRAC3 (MDLP) .....	62
<b>Playing Back a Tape</b> .....	<b>27</b>	UTOC (User Table Of Contents) .....	62
Playing Back a Tape .....	28	Sound Skip Guard Memory .....	62
<b>Recording on MDs</b> .....	<b>29</b>	SCMS (Serial Copy Management System) .....	63
Before You Start Recording on an MD .....	30	HCMS (High-speed Copy Management System) ..	63
Recording FM/AM Broadcasts .....	32	• MD limitations .....	63
Recording CD — CD Synchronized Recording ....	32	<b>MD/CD Messages</b> .....	<b>64</b>
Recording Tape		<b>Troubleshooting</b> .....	<b>65</b>
— Tape Synchronized Recording .....	33	<b>Specifications</b> .....	<b>66</b>
Recording the External Equipment			
— Sound Synchronized Recording .....	34		

# Location of the Buttons

Become familiar with the buttons on your unit.

## Main unit

(Top view)

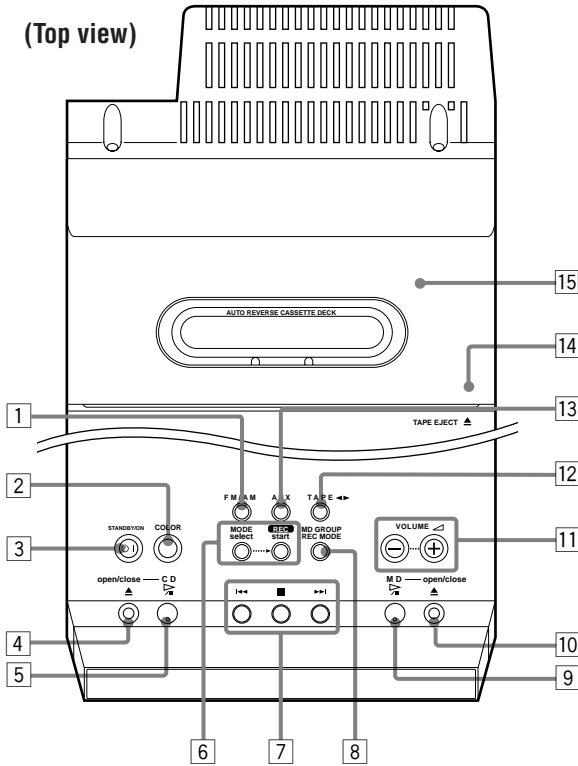

(Front view)

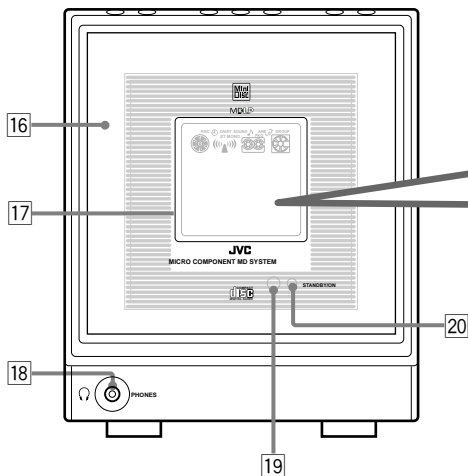

Display window on the electronic swing panel

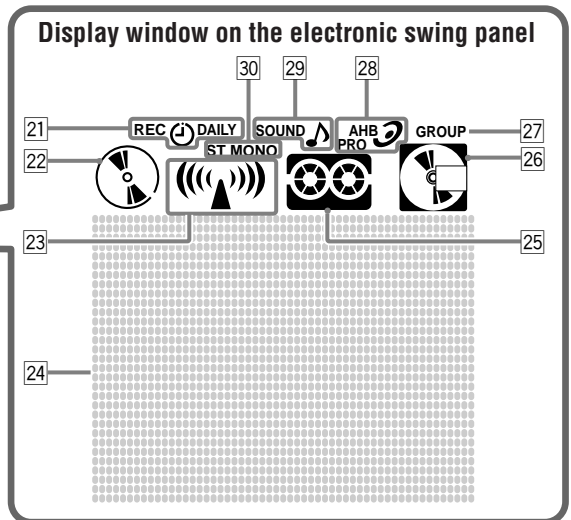



See pages in the parentheses for details.

## Main Unit

- 1 FM/AM button (11, 15)
  - Pressing this button also turns on the unit.
- 2 COLOR button (9, 13)
- 3  $\odot$ /STANDBY/ON button (11, 15)
- 4 CD open/close  $\blacktriangle$  button (18 – 20)
  - Pressing this button also turns on the unit.
- 5 CD  $\blacktriangleright$  /  $\parallel$  (play/pause) button (11, 18, 19, 32, 37, 39)
  - Pressing this button also turns on the unit.
- 6 MODE select and REC start buttons (32 – 34, 37 – 39)
- 7 Multi operation buttons
  - $\blacktriangleleft\blacktriangleleft$  (reverse search),  $\blacksquare$  (stop), and  $\blacktriangleright\blacktriangleright$  (forward search)
- 8 MD GROUP REC MODE button (32)
- 9 MD  $\blacktriangleright$  /  $\parallel$  (play/pause) button (11, 23, 24, 31, 38)
  - Pressing this button also turns on the unit.
- 10 MD open/close  $\blacktriangle$  button (23, 25, 55)
  - Pressing this button also turns on the unit.
- 11 VOLUME + / – buttons (12)
- 12 TAPE  $\blacktriangleleft\blacktriangleright$  button (11, 28, 33)
  - Pressing this button also turns on the unit.
- 13 AUX button (11, 34, 38)
  - Pressing this button also turns on the unit.
- 14 TAPE EJECT  $\blacktriangle$  portion (28)
- 15 Cassette holder (28)
- 16 Electronic swing panel
- 17 Display window
- 18 PHONES ( $\odot$ ) jack — stereo mini-type (12)
- 19 Remote sensor
- 20 STANDBY/ON lamp (11)

## Display window

- 21 Timer mode indicators
  - $\odot$  (Timer), DAILY (Daily Timer), and REC (Recording Timer)
- 22 CD indicator
  - Lights when CD is in the disc tray.
- 23 Tuner indicator
  - Lights when the tuner is selected as the source.
- 24 Main display
  - Shows the source name and other information.
- 25 Tape indicator
  - Lights when tape is in the cassette holder.
- 26 MD indicator
  - Lights when MD is in the loading slot.
- 27 GROUP indicator
  - Lights when group recording function is activated.
- 28 AHB (Active Hyper Bass) PRO indicator
- 29 SOUND indicator
- 30 ST and MONO indicators

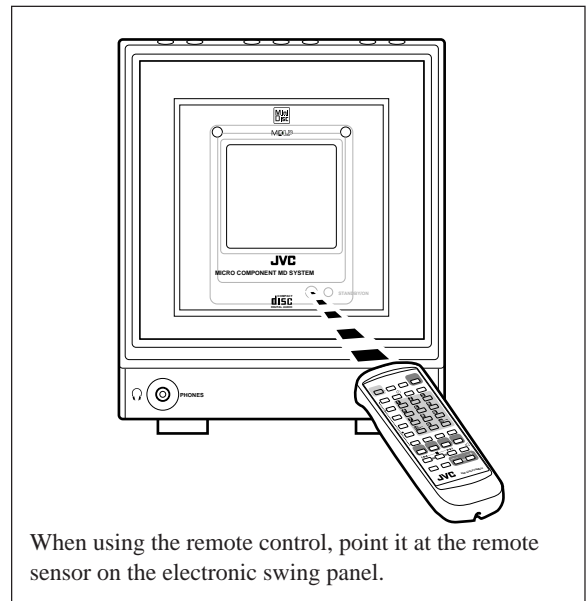

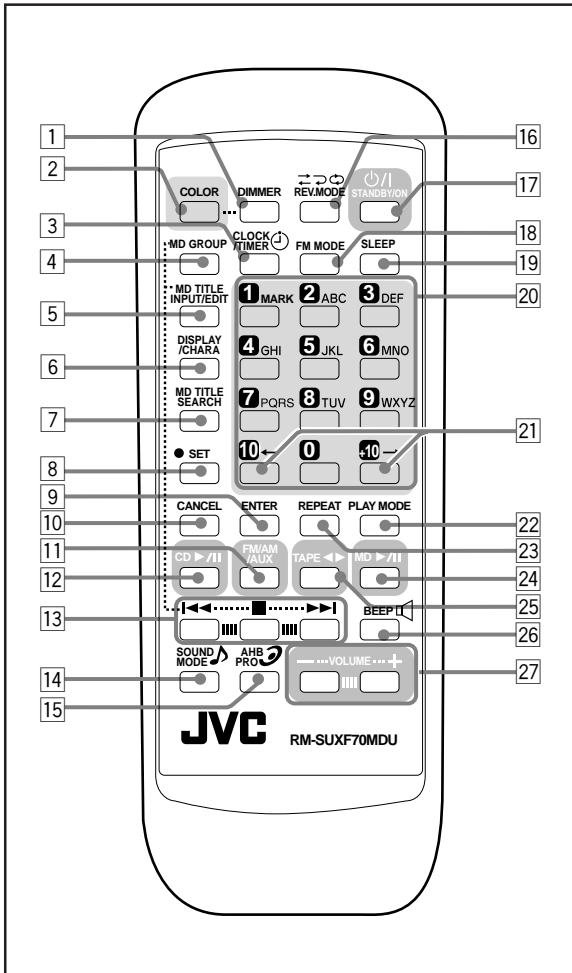

## Remote Control

- 1 DIMMER button (13, 57)
- 2 COLOR button (9, 13)
- 3 CLOCK/TIMER button (57 – 59)
- 4 MD GROUP button (43 – 47, 54)
- 5 MD TITLE INPUT/EDIT button (43 – 47, 50 – 52, 54)
- 6 DISPLAY/CHARA (character) button (16, 19, 24, 26, 28, 31 – 34, 37 – 39, 54)
- 7 MD TITLE SEARCH button (26)
- 8 SET button
- 9 ENTER button (26, 43 – 47, 50 – 52, 55)
- 10 CANCEL button
- 11 FM/AM/AUX button (11, 15, 16)
  - Pressing this button also turns on the unit.
- 12 CD ► / || (play/pause) button (11, 18 – 20)
  - Pressing this button also turns on the unit.
- 13 Multi operation buttons
  - ◀◀ (reverse search), ■ (stop), and ▶▶ (forward search)
- 14 SOUND MODE button (12)
- 15 AHB (Active Hyper Bass) PRO button (12)
- 16 REV. (reverse) MODE button (28)
- 17 ◻/ STANDBY/ON button (11, 15, 58, 59)
- 18 FM MODE button (15)
- 19 SLEEP button (60)
- 20 Number buttons
  - 1 – 10, +10 buttons
  - Character entry buttons (A – Z, 0 – 9)
- 21 ◀ / ▶ buttons (13, 26, 50, 54, 55)
- 22 PLAY MODE button (19, 20, 24 – 26)
- 23 REPEAT button (21, 26)
- 24 MD ► / || (play/pause) button (11, 23 – 26, 31)
  - Pressing this button also turns on the unit.
- 25 TAPE ◀ ▶ button (11, 28)
  - Pressing this button also turns on the unit.
- 26 BEEP button (12)
- 27 VOLUME + / – buttons (12)

## Unpacking

Make sure that you have all the following items. The number in the parenthesis indicates the quantity of the pieces supplied.

- FM antenna (1)
- AM loop antenna (1)
- AC power cord (1)
- Remote control (1)
- Batteries (2)
- Spacers (2)

If anything is missing, consult your dealer immediately.

## Connecting Antennas

### FM antenna

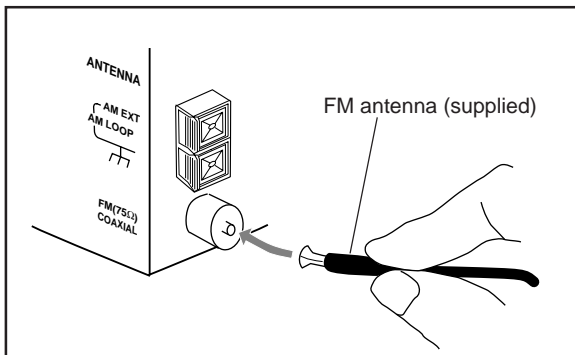

- 1** Attach the FM antenna to the FM (75 Ω) COAXIAL terminal.
- 2** Extend the FM antenna.
- 3** Fasten it up in the position which gives you the best reception.



#### About the supplied FM antenna

The FM antenna supplied with this unit can be used as temporary measure. If reception is poor, you can connect an outdoor FM antenna.

### To connect an outdoor FM antenna

Before connecting it, disconnect the supplied FM antenna.

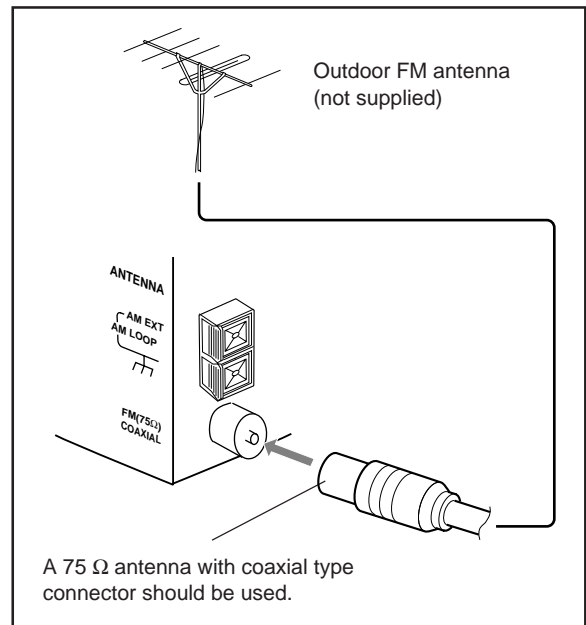

## AM antenna

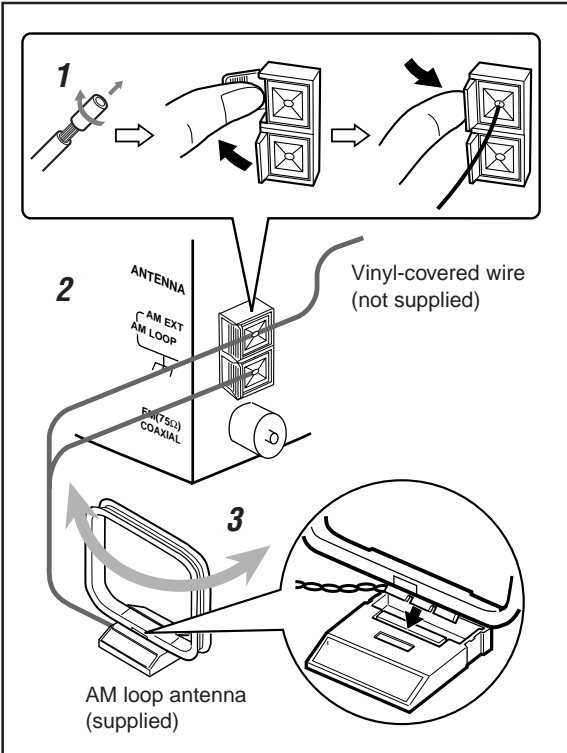

- 1** If cords are covered with insulation, twist the core of the cord at the end of each cord, then remove the insulation.
- 2** Connect the AM loop antenna to the AM LOOP terminals as illustrated.
- 3** Turn the AM loop antenna until you have the best reception.

### To connect an outdoor AM antenna

When reception is poor, connect a single vinyl-covered wire to the AM EXT terminal and extend it horizontally. The AM loop antenna must remain connected.



#### For better reception of both FM and AM

- Make sure the antenna conductors do not touch any other terminals and connecting cords.
- Keep the antennas away from metallic parts of the unit, connecting cords, and the AC power cord.

## Connecting Speakers

### To attach spacers

If you want to place the speakers beside the main unit, it is recommended to leave a space (1 cm) between the main unit and the right speaker for ventilation.

It is recommended to attach the spacers (supplied) to the right speaker as the illustration below:

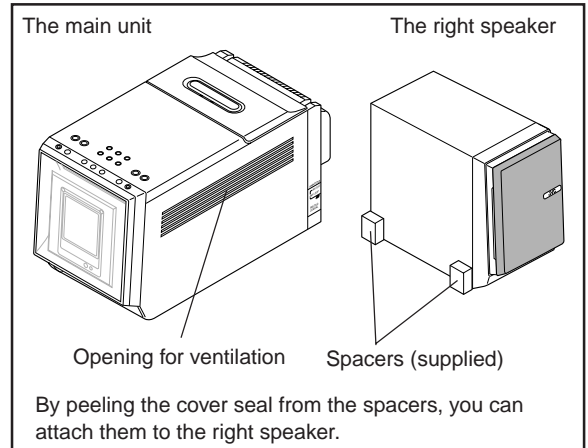

### To remove the speaker grilles

The speaker grilles are removable as the illustration below.

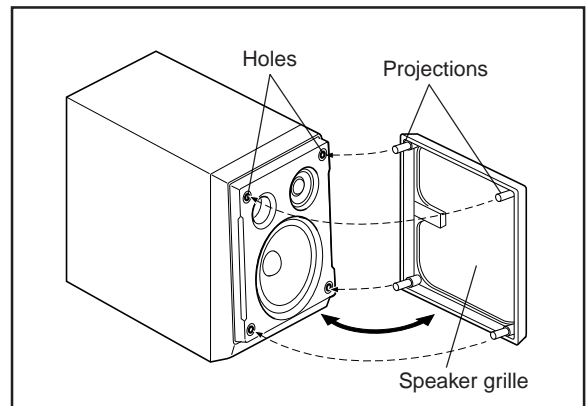

**To remove the speaker grille**, insert your fingers at the top of the speaker grille, then pull towards you. Do the same at the bottom.

**To attach the speaker grille**, put the projections of the speaker grille into the holes of the speaker.

## To connect speakers

You can connect the speakers by following the procedure below.

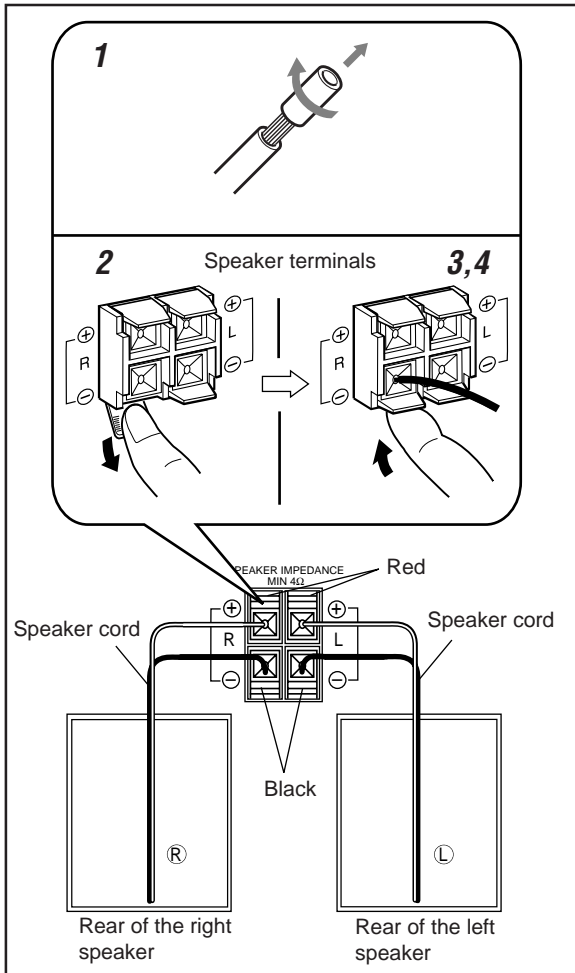

- 1** If cords are covered with insulation, twist the core of the cord at the end of each cord, then remove the insulation.
- 2** Open the speaker terminal.
- 3** Insert the end of the speaker cord to the terminal. Match the polarity: White cord to red (+) terminal and black cord to black (-) terminal.
- 4** Close the speaker terminal on the rear of the unit.

Use only speakers with the speaker impedance —  $4\ \Omega$  to  $16\ \Omega$ .

## Connecting Other Equipment

You can connect the following equipment which can be used as a playback device.

When you connect and use the equipment, refer also to its manual supplied.



- DO NOT connect other equipment while the power is on.
- DO NOT plug in any equipment until all connections are complete.

### To connect another component such as analog audio equipment

Be sure that the plugs of the audio cords and the jacks on the rear of the unit are color-coded: White plugs and jacks are for left audio signals, and red ones for right audio signals.

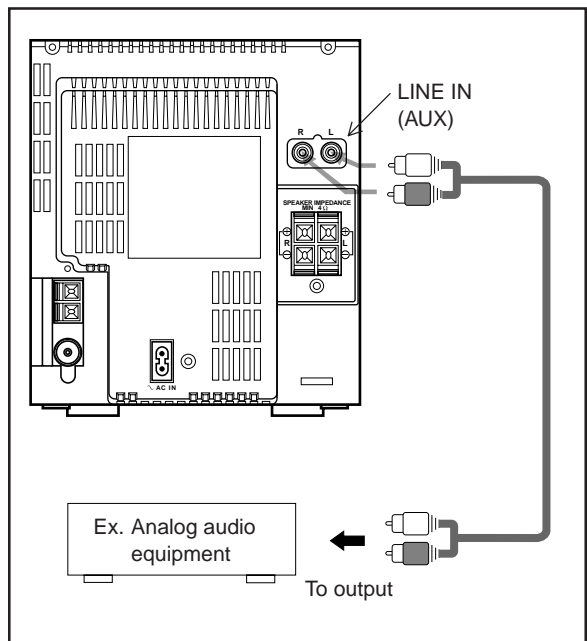

For playing the other equipment through this unit, connect between the audio output jacks on the other equipment and LINE IN (AUX) jacks by using audio cords (not supplied.)

## NOW, you can plug the AC power cord.

**IMPORTANT:** Be sure to check all connections to be done before plugging the AC power cord into a wall outlet.

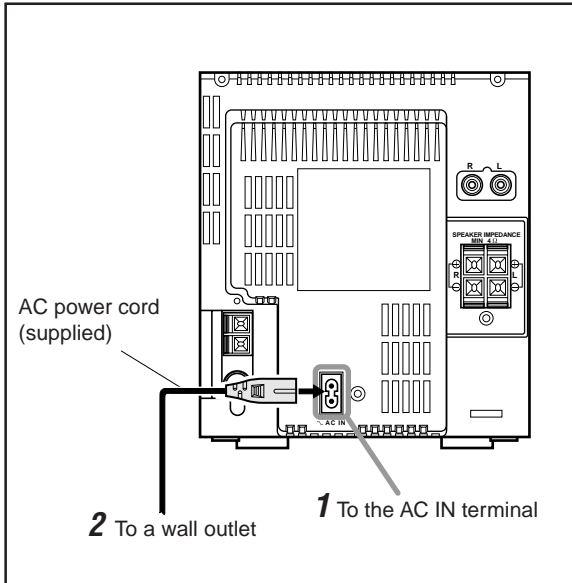

When connecting the AC power cord into a wall outlet, the unit automatically starts the display illumination.

**To stop and cancel the display demonstration,** press COLOR during display illumination — while the unit is turned off (on standby.)

**To start the display illumination manually,** press COLOR again while the unit is turned off (on standby.)

## Putting the Batteries into the Remote Control

Insert the batteries — R6P(SUM-3)/AA(15F) — into the remote control, by matching the polarity (+ and -) on the batteries with the + and - marking on the battery compartment.

When the remote control can no longer operate the unit, replace both batteries at the same time.

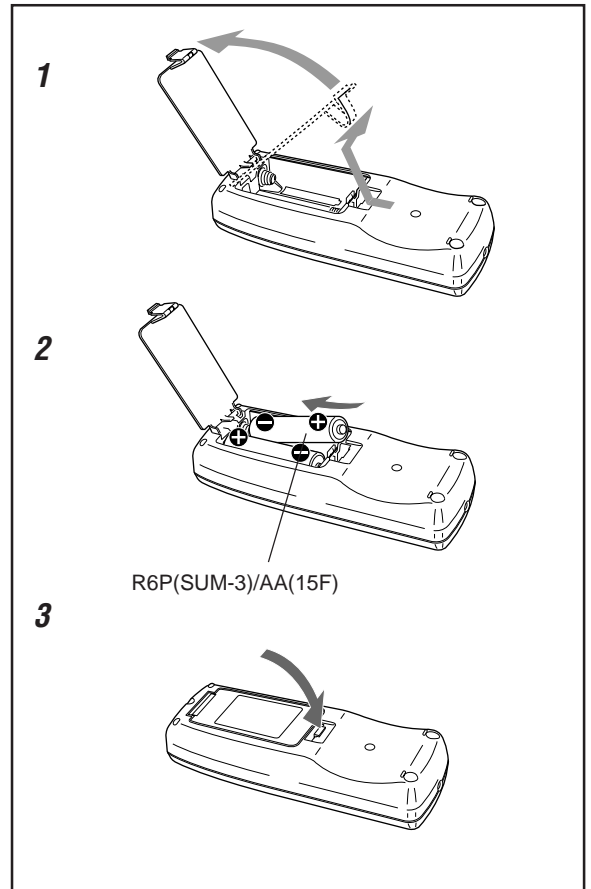

- DO NOT use an old battery together with a new one.
- DO NOT use different types of batteries together.
- DO NOT expose batteries to heat or flame.
- DO NOT leave the batteries in the battery compartment when you are not going to use the remote control for an extended period of time. Otherwise, it will be damaged from battery leakage.

# Basic and Common Operations

Continued 

The buttons emphasized in the illustration below are used and explained in this section (pages 11 to 13.)

## Remote control

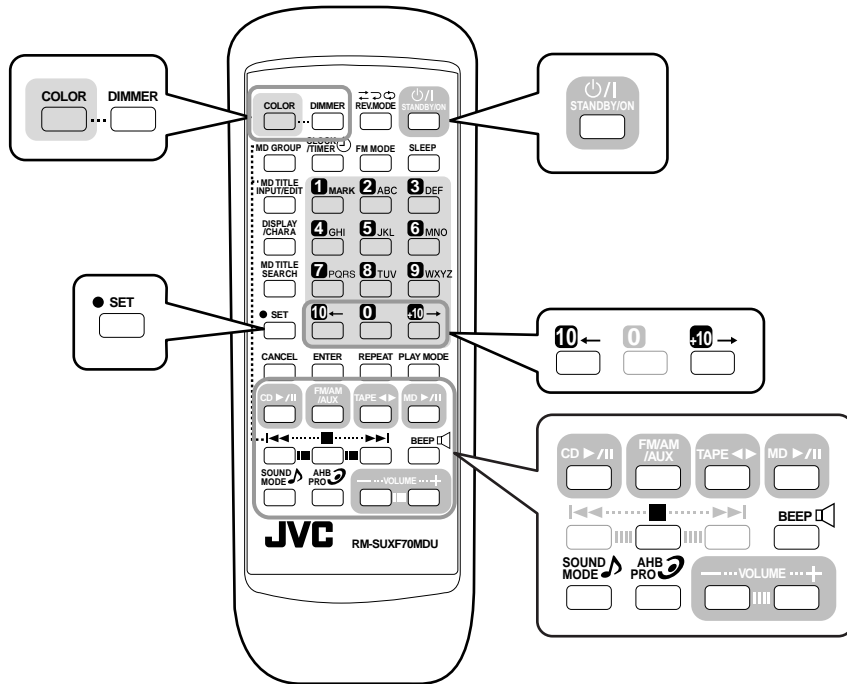

## Main unit (Top view)

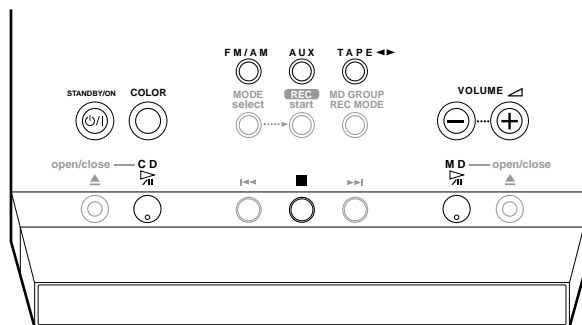

## Main unit (Front view)

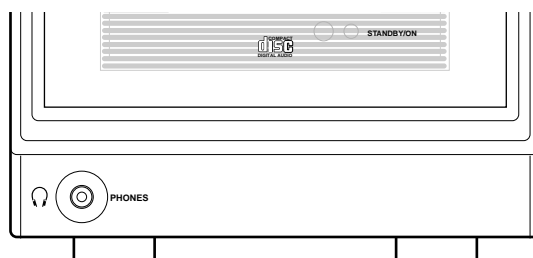

## Turning On the Power

When you press the play buttons (CD ► / ■, MD ► / ■, TAPE ◀ ►) for a particular source or the FM/AM/AUX button (or FM/AM or AUX button on the main unit), the unit automatically turns on (and starts playback if the source is ready).

**To turn on the unit without playing,** press  / STANDBY/ON.

The STANDBY/ON lamp on the electronic swing panel lights green.

**To turn off the unit (on standby),** press

 / STANDBY/ON again.

The STANDBY/ON lamp on the electronic swing panel lights red.

- “0:00” appears on the display until you set the built-in clock. After setting the clock, the clock time will appear on the display while the unit is turned off (on standby.)
- A little power is always consumed even while the unit is on standby.

**To set the built-in clock,** see page 57.

**To switch off the power supply completely,** unplug the AC power cord from the AC outlet.



**When you unplug the AC power cord or if a power failure occurs**

The clock setting, the tuner preset stations and other settings will be erased.

## Selecting the Sources and Starting Play

**To select the tuner or external equipment,** press FM/AM/AUX.

The unit automatically turns on (when the unit is on standby) and the last selected source appears on the display.

- Each time you press the button, the sources change as follows:

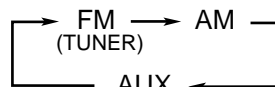

- When you change the source from the others, “TUNER” appears for a while.
- For more detailed tuner operations, see pages 14 to 16.
- For operating the external equipment, see the manuals supplied with them.

When using the main unit:

- Press FM/AM to select the tuner.
  - Each time you press the button, the band alternates between FM and AM.
- Press AUX to select the external equipment.

**To select the CD player,** press CD ► / ■.

The unit automatically turns on (when the unit is on standby), and “CD” appears on the display. Play will start if a CD is on the disc tray. (“NO DISC” will appear on the display if a CD is not loaded.)

To stop playback, press ■.

- For more detailed operations, see pages 17 to 21.

**To select the MD player,** press MD ► / ■.

The unit automatically turns on (when the unit is on standby), and “MD” appears on the display. Play will start if an MD is in the MD loading slot. (“NO DISC” will appear on the display if an MD is not loaded.)

To stop playback, press ■.

- For more detailed operations, see pages 22 to 26.

**To select the tape,** press TAPE ◀ ►.

The unit automatically turns on (when the unit is on standby), and “TAPE” appears on the display. Play will start if a tape is in the cassette holder. (“NO TAPE” will appear on the display if a tape is not in the cassette holder.)

To stop playback, press ■.

- For more detailed operations, see pages 27 and 28.



## Adjusting the Volume

You can adjust the volume level only while the unit is turned on. The volume level has no effect on recording.

**To increase the volume,** press VOLUME + .

**To decrease the volume,** press VOLUME – .

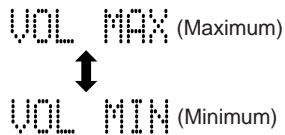

The volume level meter appears on the display.

- The volume level can be adjusted in 41 steps (VOL MIN, VOL 1 – VOL 39, and VOL MAX.)
- When pressing and holding the button, you can change the volume level continuously.



### For private listening

Connect a pair of headphones to the PHONES jack. No sound comes out of the speakers. Be sure to turn down the volume before connecting or putting on the headphones.



### If “CANNOT LISTEN!” appears on the display

During high-speed recording (see page 31), you cannot listen to any source, and therefore, cannot adjust the volume level.



DO NOT turn off (on standby) the unit with the volume set to an extremely high level; otherwise, the sudden blast of sound can damage your hearing, speakers and/or headphones when you turn on the unit or start playing any source.  
REMEMBER you cannot adjust the volume level while the unit is in standby mode.

## Turning On/Off the Key-touch Tone

You can deactivate the key-touch tone if you do not want it to beep each time you press the button.

### On the remote control ONLY:

Press BEEP.

- Each time you press the button, the key-touch tone turns on (BEEP ON) and off (BEEP OFF) alternately:

BEEP ON ↔ BEEP OFF

## Reinforcing the Bass Sound

The richness and fullness of the bass sound is clearly maintained regardless of how low you set the volume — Active Hyper Bass Pro. The AHB PRO effect can be applied only to playback sounds, and cannot be used for recording.

### On the remote control ONLY:

**To get the effect,** press AHB PRO.

The AHB PRO indicator lights on the display.

- Each time you press the button, the effect changes as follows:

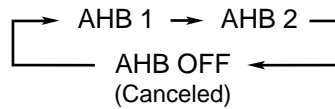

**AHB 1:** Bass sound is clearly heard even in the low volume.

**AHB 2:** More richness and fullness of the bass sound is heard.

**AHB OFF:** Cancels the AHB PRO effect.

The AHB PRO indicator goes off from the display.

**To check the AHB PRO setting currently selected,** press AHB PRO once while the AHB PRO indicator is lit.

## Selecting the Sound Modes

You can select one of the 4 preset sound modes. The sound modes can be applied only to playback sounds, and cannot be used for recording.

### On the remote control ONLY:

**To select the sound modes,** press SOUND MODE repeatedly until the sound mode you want appears on the display.

The SOUND indicator also lights on the display.

- Each time you press the button, the sound mode changes as follows:

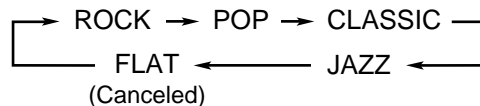

**ROCK:** Boosts low and high frequency. Good for acoustic music.

**POP:** Good for vocal music or voice.

**CLASSIC:** Good for classical music.

**JAZZ:** Good for jazz music.

**FLAT:** Cancels the sound mode.

The SOUND indicator goes off from the display.

**To check the sound mode currently selected,** press SOUND MODE once while the SOUND indicator is lit.

## Setting the Display Illumination

You can change the color and brightness of the display illumination.

### To select the color pattern

You can select the color pattern by your preference.

- If you press COLOR while the unit is turned off, the display illumination will start (see page 9.)

While the unit is turned on, press COLOR repeatedly until the color pattern you want appears on the display.

- Each time you press the button, the color pattern changes as follows:

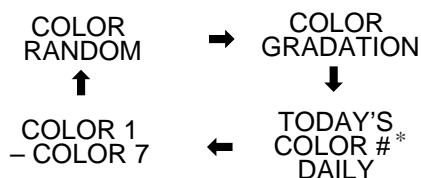

**COLOR RANDOM:** Changes the illumination color randomly every 2 seconds.

**COLOR GRADATION:**  
Changes the illumination color gradually.

**TODAY'S COLOR #\* DAILY:**  
Changes the illumination color every day. You can select which color to be started with. (See "To set TODAY'S COLOR" to the right.)

\* The color number of TODAY'S COLOR is selected from COLOR 1 – 7.

**COLOR 1 – 7:** You can adjust and register the color from COLOR 1 to 7. (See "To adjust and register the color" to the right.)



### More on the display illumination

- The colors shown on the display cannot always be reproduced precisely. Due to the circumstances (room temperature, etc.) where the unit is used, colors may vary slightly.
- When you change the color of the display, the display may seem to move back and forth; this is a characteristic of this unit and is not a malfunction.
- When a strong light strikes the display, the display happens to become dark, but this is not a malfunction.

### To adjust and register the color

You can adjust the color by changing the tone, whiteness, brightness, and register into COLOR 1 to 7.

- There is a time limit in doing the following steps. If the setting is canceled before you finish, start from step 1 again.

#### On the remote control ONLY:

- 1 Press COLOR repeatedly until the color number (COLOR 1 to 7) you want to adjust appears on the display.

The adjustment bars appear on the display.



- 2 Adjust the tone, whiteness and brightness.

- 1) Press → or ← to select the level you want and press SET.

Each time you press SET, the adjustment items change.

The tone can be adjusted in 14 patterns. The whiteness can be adjusted in 3 levels and the brightness can be adjusted in 2 levels.

- 2) Repeat step 1 to adjust "WHITENESS" and "BRIGHTNESS."

- If the whiteness is set to the right end, the tone you adjusted will be no longer valid.

### To set "TODAY'S COLOR"

The illumination color changes automatically each time the built-in clock becomes "0:00."

- There is a time limit in doing the following steps. If the setting is canceled before you finish, start from step 1 again.

#### On the remote control ONLY:

- 1 Press COLOR repeatedly until "TODAY'S COLOR" appears on the display.

- 2 Press → and ← to select the color number (COLOR 1 to 7.)

### To dim the display

This function can be used only while the unit is turned on.

#### On the remote control ONLY:

To dim the display, press DIMMER.

To brighten the display, press DIMMER again.

- Press COLOR also brightens the display.

# Listening to FM and AM Broadcasts

Continued

The buttons emphasized in the illustration below are used and explained in this section (pages 15 and 16.)

## Remote control

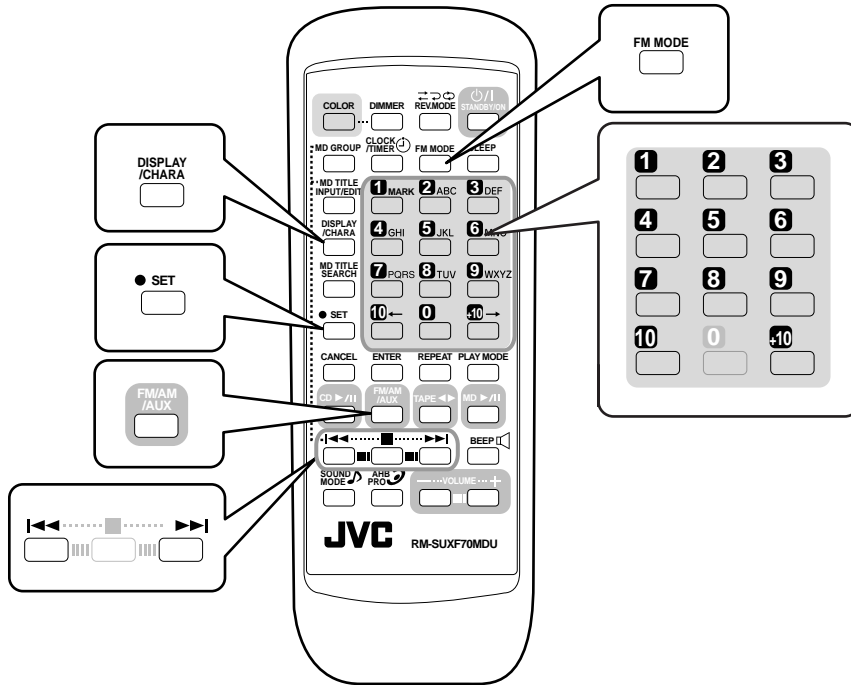

## Main unit (Top view)

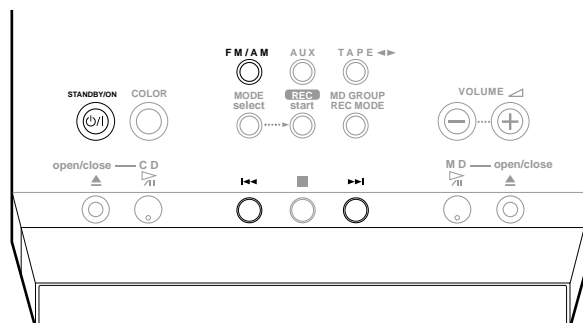

## Setting the AM Tuner Interval Spacing

Some countries space AM stations 9 kHz apart, and some countries use 10 kHz spacing.

When shipped, the built-in AM tuner is set to 9 kHz spacing. You can change it to 9 kHz or 10 kHz spacing.

### On the main unit ONLY:

**To set the AM tuner to the 10 kHz spacing,** be sure that the unit is turned off, but is plugged into a wall outlet.

While holding **▶▶**, press **⏻/I** STANDBY/ON. The unit turns on and “AM 10 kHz” appears on the display for a while.

**To set it back to the 9 kHz spacing,** be sure that the unit is turned off, but is plugged into a wall outlet.

While holding **◀◀**, press **⏻/I** STANDBY/ON. The unit turns on and “AM 9 kHz” appears on the display for a while.

## Tuning in a Station

### 1 Press FM/AM/AUX (or FM/AM on the main unit) repeatedly to select “FM” or “AM.”

The unit automatically turns on with the last source selected.

- Each time you press the button, the source changes as follows:

When using the remote control:

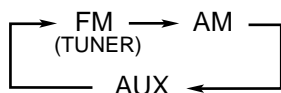

When using the main unit:

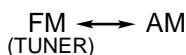

### 2 Press and hold **▶▶** or **◀◀** until the station frequencies start changing continuously on the display.

- ▶▶**: to increase the frequencies.
- ◀◀**: to decrease the frequencies.

The unit starts searching stations and stops when a station of sufficient signal strength is tuned in.

FM  
87.50MHz

Ex. An FM station is tuned in.

- If an FM program is broadcast in stereo, the ST (stereo) indicator lights on the display.

To stop during searching, press **▶▶** or **◀◀**.



When you repeatedly press **▶▶** or **◀◀**

The frequency changes step by step.

## To change the FM reception mode

When an FM stereo broadcast is noisy or hard to receive, you can change the FM reception mode to improve the reception.

### On the remote control ONLY:

Press **FM MODE** so that the **MONO** indicator lights on the display.

- Each time you press the button, **MONO** indicator lights and goes off alternately.

### When the **MONO** indicator is lit:

Reception improves though stereo effect is lost.

### When the **MONO** indicator is not lit:

You can hear stereo sound when a program is broadcast in stereo.

The **ST** indicator lights while receiving the FM stereo broadcast.

In addition, static noise between stations will be erased while tuning.

## Presetting Stations

You can preset 30 FM and 15 AM stations manually.

In some cases, test frequencies have been already memorized for the tuner since the factory examined the tuner preset function before shipment. This is not a malfunction. You can preset the stations you want into memory by following the presetting method.

- There is a time limit in doing the following steps. If the setting is canceled before you finish, start from step **2** again.

### On the remote control ONLY:

#### 1 Tune in a station you want to preset.

- See “Tuning in a Station” to the left.

#### 2 Press SET.

The preset number starts flashing as follows:

- When you select an FM station in step **1**

FM-P 1

- When you select an AM station in step **1**

AM-P 1

Preset No. 1 always appears at first.

**3** Press the number buttons to select a preset number.

Ex. For preset number 5, press 5.

For preset number 15, press +10, then 5.

For preset number 20, press +10, then 10.

For preset number 30, press +10, +10, then 10.

- You can also select the preset number by pressing ►►1 or 1◀◀.

**4** Press SET again.

“STORED” appears on the display for a while.

STORED

The tuned station in step **1** is stored in the preset number selected in step **3**.

- Storing a new station on a used number erases the previously stored one.



**notes** When you unplug the AC power cord or if a power failure occurs

The preset stations will be erased. If this happens, preset the stations again.

## Tuning in a Preset Station

---

**On the remote control ONLY:**

**1** Press FM/AM/AUX repeatedly to select “FM” or “AM.”

The unit automatically turns on with the last source selected.

- Each time you press the button, the source changes as follows:

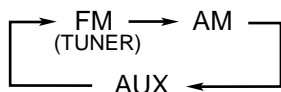
**2** Press the number buttons to select a preset number.

Ex. For preset number 5, press 5.

For preset number 15, press +10, then 5.

For preset number 20, press +10, then 10.

For preset number 30, press +10, +10, then 10.

# Playing Back a CD

The buttons emphasized in the illustration below are used and explained in this section (pages 18 to 21.)

## Remote control

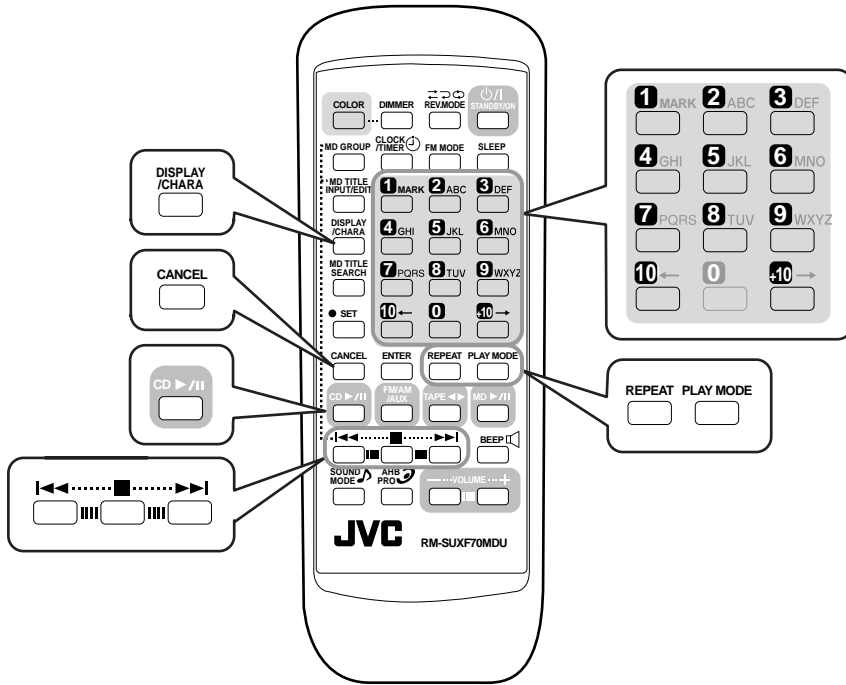

## Main unit (Top view)

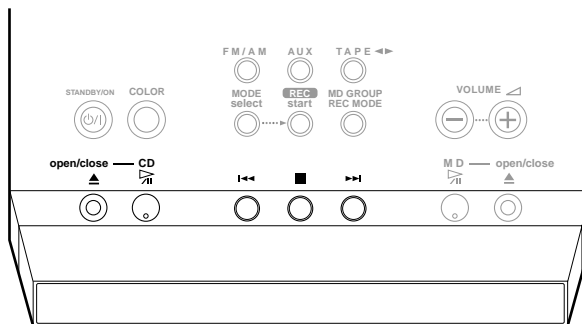

## Precautions on CD Playback

This unit has been designed to play back discs bearing the following logos:



CD ReWritable (CD-RW)



CD Recordable (CD-R)



Audio CD

In addition to the above discs, this unit can play back audio data recorded on CD Text, CD-G (CD Graphics), and CD-Extra.

### When playing a CD-R or CD-RW

User-edited CD-Rs (CD-Recordable) and CD-RWs (CD-ReWritable) can be played back when they are already **“finalized.”** If you play back the **unfinalized** CDs, **“UNFINALIZE”** appears on the display.

- You can play back your original CD-Rs or CD-RWs recorded in **music CD format ONLY.** (If CD-RWs have been recorded in different format, erase all the data on CD-RWs completely before re-recording on the discs.)



DO NOT play back CD-Rs or CD-RWs recorded the sound files such as MP3.

- Before playing back CD-Rs or CD-RWs, read their instructions or cautions carefully.
- Some CD-Rs or CD-RWs may not be played back on this unit because of their disc characteristics, damage or stain on them, or if the player's lens is dirty.

### Important notices:

- In general, you will have the best performance by keeping your CDs and the mechanism clean.
  - Store CDs in their cases, and keep them in cabinets or on shelves.
  - Keep the unit's disc tray closed when not in use.
- Continuous use of irregular shaped discs (heart-shape, octagonal, etc.) can damage the disc rotating mechanism.

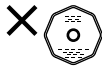
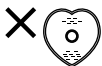

- CD-RWs may require a longer readout time. This is caused by the fact that the reflectance of CD-RWs is lower than for regular CDs.

## Playing Back the Entire CD — Normal Play

You can play a CD.

### 1 Press CD open/close ▲ on the main unit.

The unit automatically turns on, the electronic swing panel slides upward, then the disc tray comes out.

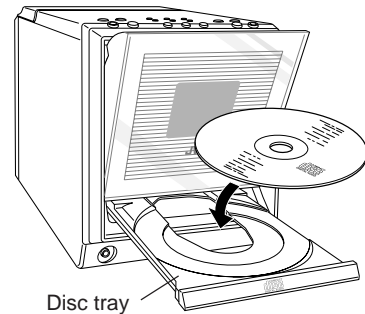

### 2 Place a CD correctly on the circle of the disc tray with its label side up.

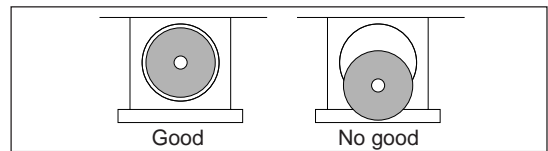

- When using a CD single (8 cm), place it on the inner circle of the disc tray.

### 3 Press CD ► / II.

The disc tray closes, then the electronic swing panel slides downward automatically. The CD indicator starts rotating on the display and CD playback starts from the first track.

- If you press CD open/close ▲ again, the disc tray and the electronic swing panel slides downward automatically, but CD playback does not start until you press CD ► / II.

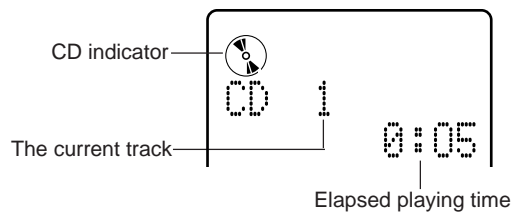

CD playback stops automatically after playing all the tracks on the CD.

To stop during play, press ■.  
The following informations appear.

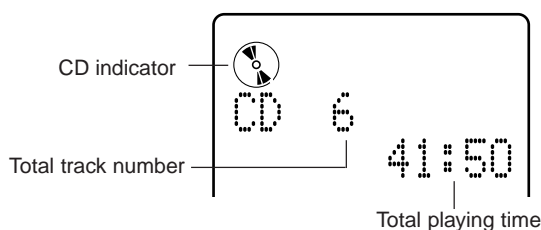

To remove the disc, press CD open/close ▲.

## Basic CD Operations

While playing a CD, you can do the following operations.

### To stop playback for a moment

Press CD ► / II.

The elapsed playing time starts flashing on the display.

To resume playback, press CD ► / II again.

### To locate a particular point in a track during play

Press and hold ►► or ◀◀.

- ►►: Fast-forwards the tracks.
- ◀◀: Fast-reverses the tracks.

### To go to another track

Press ►► or ◀◀ repeatedly.

- ►►: Skips to the beginning of the next or succeeding tracks.
- ◀◀: Goes back to the beginning of the current or previous tracks.

### To go to another track directly using the number buttons

#### On the remote control ONLY:

Pressing the number button(s) allows you to start playing the track number you want.

- Ex.: For track number 5, press 5.  
For track number 15, press +10, then 5.  
For track number 20, press +10, then 10.  
For track number 32, press +10, +10, +10, then 2.

### To check the clock time while playing back CD

#### On the remote control ONLY:

Press DISPLAY/CHARA.

- Each time you press the button, the disc informations and the clock time alternate on the display.

## Programing the Playing Order of the Tracks — Program Play

You can arrange the order in which the tracks play before you start playing. You can program up to 32 tracks.

#### On the remote control ONLY:

- 1 Load a CD.
- 2 Press CD ► / II, then ■.  
The source is changed to "CD."
- 3 Press PLAY MODE repeatedly until "PROGRAM" appears on the display.

- Each time you press the button, play mode changes as follows:

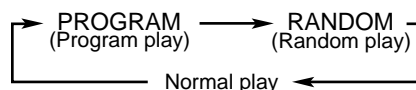

- 4 Press the number buttons to select the tracks.

- For how to use the number buttons, see "To go to another track directly using the number buttons" to the left.

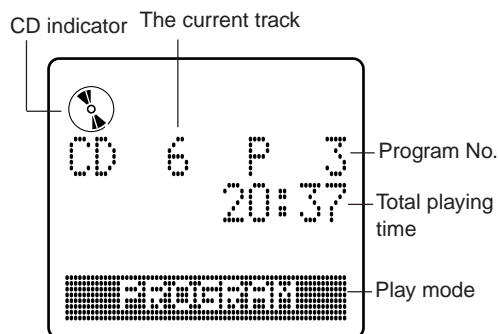

- 5 Press CD ► / II.

- The tracks are played in the order you have programmed. The Program play ends when all the tracks are played once.

To stop during play, press ■.

To exit from Program play mode, press PLAY MODE repeatedly so that the unit enters another playback mode (Random play or Normal play mode) before or after play.



### To check the program contents

Before playing, you can check the program contents by pressing ►►| or |◄◄.

- ►►| : Shows tracks in the programmed order.
- |◄◄ : Shows the programmed tracks in the reverse order.

### To modify the program

Before or after playing, you can erase the last programmed track by pressing CANCEL. Each time you press the button, the last programmed track is erased from the program.

**To add tracks in the program before you start play,** press the number buttons to select track numbers you want to add.

**To erase the entire program,** press CD open/close ▲ to eject the CD.

- Turning off the unit will also erase the program.



**If you try to program a 33rd step**  
“MEMORY FULL” will appear on the display.



**If your entry is ignored**

You have tried to program a track number that does not exist on the CD (for example, selecting track 14 on a CD that only has 12 tracks.) Such entries are ignored.



**If the total playing time is 100 minutes (one hour and 40 minutes) or more**

The total playing time will not be shown. (“- - : - -” will appear.)

## Playing at Random — Random Play

The tracks of a loaded CD will play at random.

### On the remote control ONLY:

- 1 Load a CD.
- 2 Press CD ► / II, then ■.  
The source is changed to “CD.”
- 3 Press PLAY MODE repeatedly until “RANDOM” appears on the display.
  - Each time you press the button, play mode changes as follows:

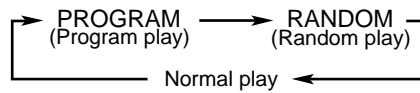

- 4 Press CD ► / II.

The tracks are played at random.

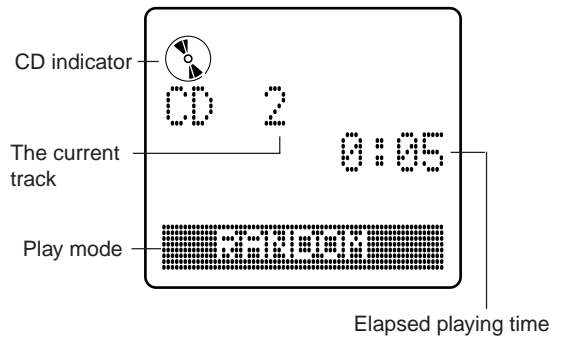

Random play stops when all the tracks are played once.

**To stop during play,** press ■.

**To skip the current track,** press ►►|.

- You cannot go back to the previous tracks by pressing |◄◄.

**To exit from Random play mode,** press PLAY MODE repeatedly so that the unit enters another playback mode (Normal play or Program play mode) before or after play.

## Repeating Tracks — Repeat Play

You can have all the tracks, a program or the individual track currently playing repeat as many times as you like.

### On the remote control ONLY:

To repeat play, press REPEAT before or during play.

- Each time you press the button, Repeat play mode changes as follows:

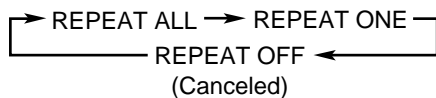

**REPEAT ALL** : Repeats all the tracks on the CD (in Normal play or Random play mode), or all the tracks in the program.

**REPEAT ONE** : Repeats one track.

**REPEAT OFF** : Cancels the repeat play.

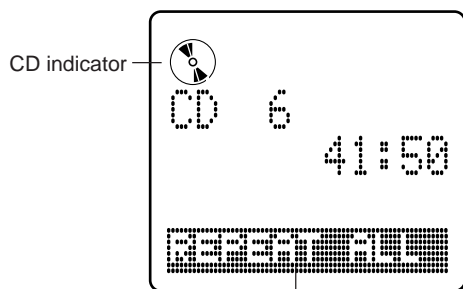

Repeat mode indication (ex. REPEAT ALL)

- If the play mode is either Program or Random, the repeat mode indication appears on the display for a while each time you press REPEAT.

To exit from Repeat play mode, press REPEAT repeatedly until “REPEAT OFF” appears on the display.

The buttons emphasized in the illustration below are used and explained in this section (pages 23 to 26.)

## Remote control

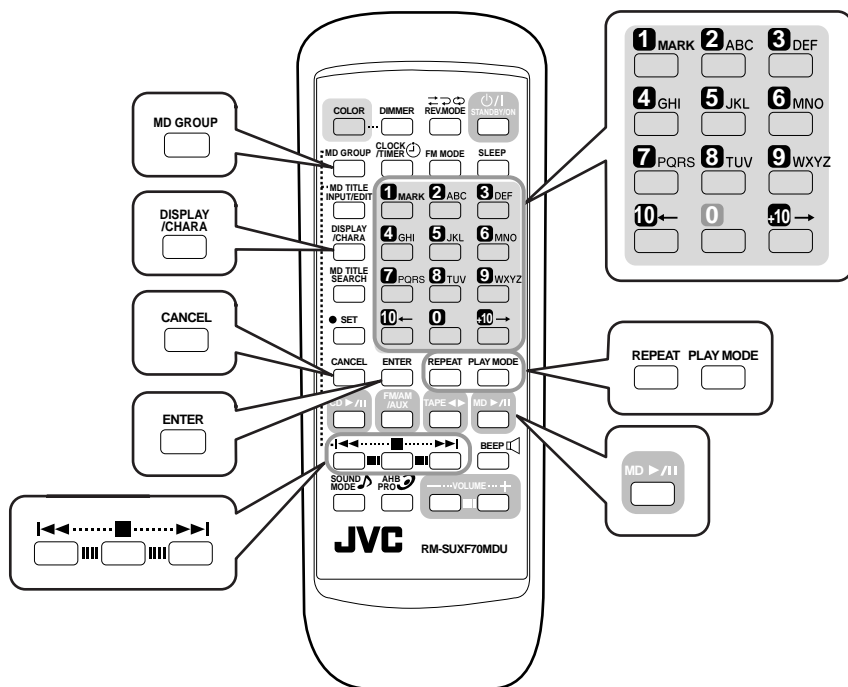

## Main unit (Top view)

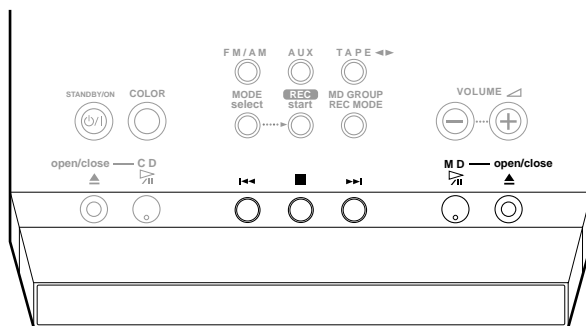

## Playing Back the Entire MD — Normal Play

You can play an MD.

### 1 Press MD open/close ▲ on the main unit.

The unit automatically turns on, the electronic swing panel slides downward, so the MD loading slot appears.

- If an MD is already in the MD loading slot, it will eject.

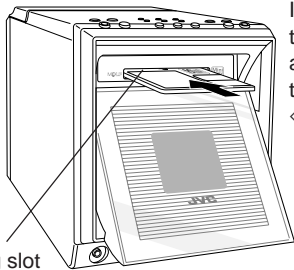

Insert an MD in the same way as indicated on the MD such as ← or ▶.

MD loading slot

### 2 Insert an MD into the MD loading slot.

The MD is pulled in, then the electronic swing panel slides upward automatically.

- When the current source is MD, the information on the loaded MD appears on the display as follows:

Loading  
↓  
TOC Reading  
↓

Total track number, total playing time, and disc title\*

- \* If the loaded MD does not have a disc title, "NO TITLE" will appear.

### 3 Press MD ▶ / II.

The MD indicator start rotating on the display and MD playback starts from the first track.

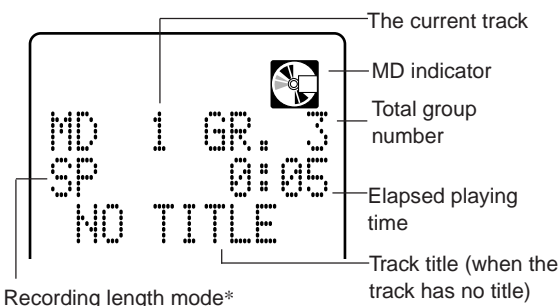

MD playback stops automatically after playing all the tracks on the MD.

To stop during play, press ■.

To remove the MD, press MD open/close ▲.

- After pulling out the MD, press MD open/close ▲ again to close the electric swing panel.



While the unit is pulling the MD into the MD loading slot :

- DO NOT press MD open/close ▲.



**If the MD or track has a title**

The title will appear on the display. (If a title is long and cannot be shown at a time, the unit scrolls the title to show the entire title.)



\* About recording length mode — MDLP: see page 31

MDs are played back in the same recording length mode as they were recorded. When an MD starts playing, the recording length mode of the currently playing track lights on the display.

**SP** : Indicates the tracks recorded in standard stereo recording mode.

**LP2** : Indicates the tracks recorded in 2 times long-hour stereo recording mode.

**LP4** : Indicates the tracks recorded in 4 times long-hour stereo recording mode.

MDLP features a sound compression method called ATRAC3, and enables a 2 times (or 4 times) long-hour stereo recording and playing.

The MDLP logo is marked on the MD recorders and players compatible with MDLP. It is also marked on MDs pre-recorded in ATRAC3 (excluding recordable MDs.)

## Basic MD Operations

While playing an MD, you can do the following operations.

### To stop playback for a moment

Press MD ► / ■.

The elapsed playing time start flashing on the display.

To resume playback, press MD ► / ■ again.

### To locate a particular point in a track during play

Press and hold ►► or ◀◀.

- ►►: Fast-forwards the tracks.
- ◀◀: Fast-reverses the tracks.

### To go to another track

Press ►► or ◀◀ repeatedly.

- ►►: Skips to the beginning of the next or succeeding tracks.
- ◀◀: Goes back to the beginning of the current or previous tracks.

### To go to another track directly using the number buttons

**On the remote control ONLY:**

Pressing the number button(s) allows you to start playing the track number you want.

Ex.: For track number 5, press 5.

For track number 15, press +10, then 5.

For track number 20, press +10, then 10.

For track number 32, press +10, +10, +10, then 2.

### To change the informations on the display

**On the remote control ONLY:**

Press DISPLAY/CHARA.

- Each time you press the button, the informations on the loaded MD change as follows:

#### ■ When playing or pausing:

Normal source playing indication  
 → Group title and play mode  
 → Remaining recording time  
 → Clock time → (back to the beginning)

#### ■ When the MD recorder stops:

Normal source indication  
 → Remaining recording time  
 → Clock time → (back to the beginning)

## Programming the Playing Order of the Tracks — Program Play

You can arrange the order in which the tracks play before you start playing. You can program up to 32 tracks.

**On the remote control ONLY:**

**1** Insert an MD.

**2** Press MD ► / ■, then ■.

■ The source is changed to “MD.”

**3** Press PLAY MODE repeatedly until “PROGRAM” appears on the display.

- Each time you press the button, play mode changes as follows:

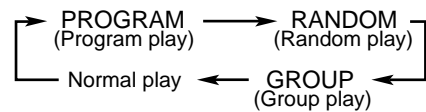

**4** Press the number buttons to select the tracks.

- For how to use the number buttons, see “To go to another track directly using the number buttons” to the left.

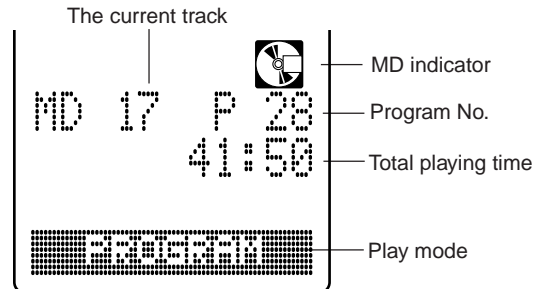

**5** Press MD ► / ■.

- The tracks are played in the order you have programmed.
- Program play ends when all the tracks are played once.

To stop during play, press ■.

To exit from Program play mode, press PLAY MODE repeatedly so that the unit enters another playback mode before or after play.

## To check the program contents

Before playing, you can check the program contents by pressing **◀◀** or **▶▶**.

- **◀◀**: Shows the programmed tracks in the reverse order.
- **▶▶**: Shows the tracks in the programmed order.

## To modify the program

Before or after playing, you can erase the last programmed track by pressing **CANCEL**. Each time you press the button, the last programmed track is erased from the program.

**To add tracks in the program before you start play**, press the number buttons to select track numbers you want to add.

**To erase the entire program**, press **MD** open/close **▲** to eject the MD.

- Turning off the unit will also erase the program.



**If you try to program a 33rd step** “MEMORY FULL” will appear on the display.



**If your entry is ignored**  
You have tried to program a track number that does not exist on the MD (for example, selecting track 14 on an MD that only has 12 tracks.) Such entries are ignored.



**If the total playing time is 150 minutes (2 hours and 30 minutes) or more**  
The total playing time will not be shown.

## Playing at Random — Random Play

The tracks of the loaded MD will play at random.

### On the remote control ONLY:

- 1** Insert an MD.
- 2** Press **MD ▶ / II**, then **■**.  
The source is changed to “MD.”
- 3** Press **PLAY MODE** repeatedly until “RANDOM” appears on the display.
  - Each time you press the button, play mode changes as follows:

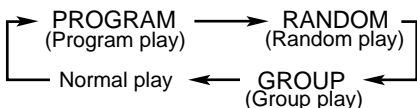

## 4 Press **MD ▶ / II**.

The tracks are played at random.

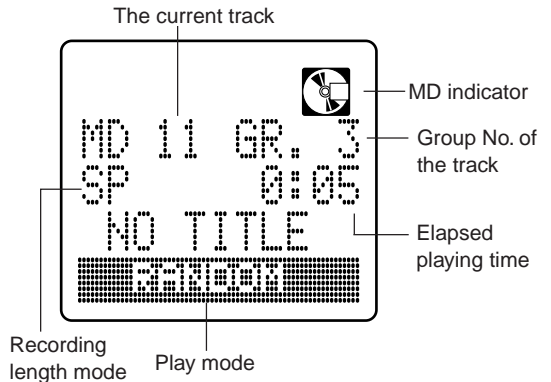

Random play stops when all the tracks are played once.

**To stop during play**, press **■**.

**To skip the current track**, press **▶▶**.

- You cannot go back to the previous tracks by pressing **◀◀**.

**To exit from Random play mode**, press **PLAY MODE** repeatedly so that the unit enters another playback mode before or after play.

## Playing Tracks in a Group — Group Play

You can playback the tracks in the same group.  
To make a group etc., see pages 40 to 47.

### On the remote control ONLY:

- 1** Insert an MD.
- 2** Press **MD ▶ / II**, then **■**.  
The source is changed to “MD.”
- 3** Press **PLAY MODE** repeatedly until “GROUP” appears on the display.
  - Each time you press the button, play mode changes as follows:

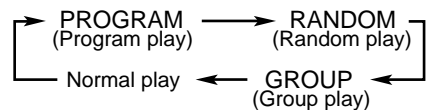

- 4** Press **◀◀** or **▶▶** while pressing **MD GROUP** to select a group.

## 5 Press MD ► / II.

All the tracks in a group are played.

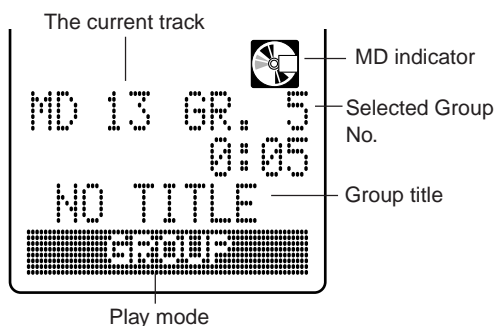

Group play stops when all the tracks in a group are played once.

To stop during play, press ■.

To exit from Group play mode, press PLAY MODE repeatedly so that the unit enters another playback mode before or after play.

## Repeating Tracks — Repeat Play

You can have all the tracks, a program, a group, or the individual track currently playing repeat as many times as you like.

**On the remote control ONLY:**

To repeat play, press REPEAT before or during play.

- Each time you press the button, Repeat play mode changes as follows:

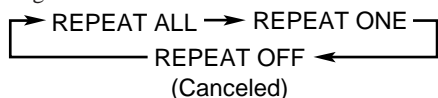

**REPEAT ALL:** Repeats all the tracks on the MD (in Normal play or Random play mode), or all the tracks in the program or in a group.

**REPEAT ONE:** Repeats one track.

**REPEAT OFF:** Cancels the repeat play.

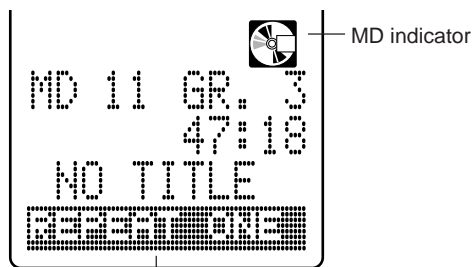

Repeat mode indication (ex. REPEAT ONE)

- If the play mode is Program, Random or Group, the repeat mode indication appears on the display for a while each time you press REPEAT.

To exit from Repeat play mode, press REPEAT repeatedly until “REPEAT OFF” appears on the display.

## Searching by Title of the Track — MD Title Search

You can playback a track by searching its title.

- You cannot perform title search for the tracks without titles.
- You can search a title while playing back an MD.

**On the remote control ONLY:**

### 1 Insert an MD.

- If the current source is not an MD, press MD ► / II, then ■.

### 2 Press MD TITLE SEARCH.

The unit enters the title input screen.

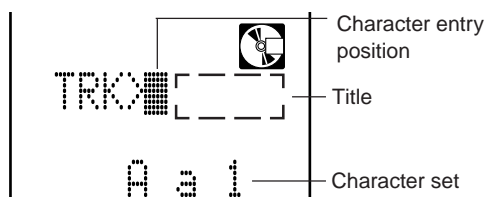

### 3 Input the title of the track.

You can input up to the first 5 letters of the track you want to playback.

- You can use the following buttons to input the character (Refer to “Assigning Titles to an MD” on page 53.):

**DISPLAY/CHARA :** To select the character set

**Number buttons :** To input a character/numeral

← or → : To move the character entry position

**CANCEL :** To cancel the incorrect entry

### 4 Press ENTER.

“SEARCH” appears on the display. When the track is found, the unit starts playing back the track.

The title search will start again when the track played back is over.

- If the track is not found, “SEARCH END” appears.

To find the next track while playing searched track, press ►►.

The unit start searching for the next track you want to find.

To stop searching, press MD TITLE SEARCH.

Search mode is canceled and Normal play mode resumes.

# Playing Back a Tape

The buttons emphasized in the illustration below are used and explained in this section (page 28.)

## Remote control

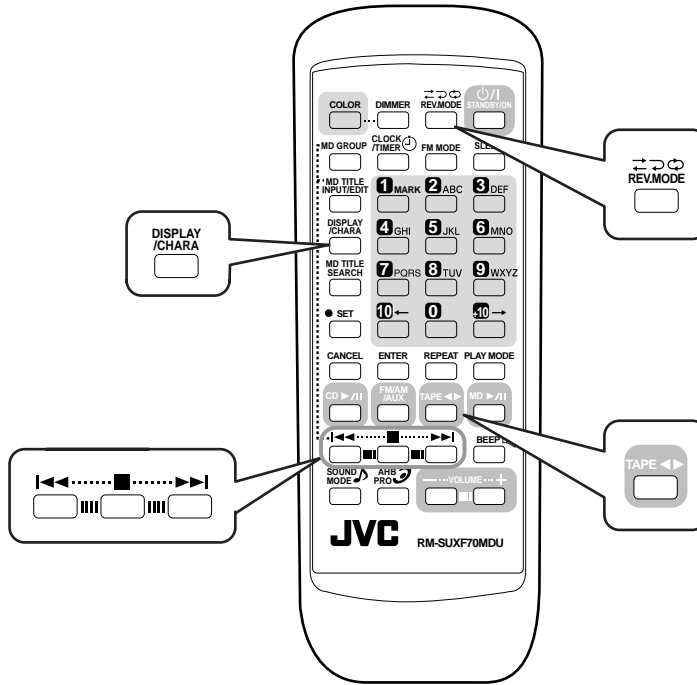

## Main unit (Top view)

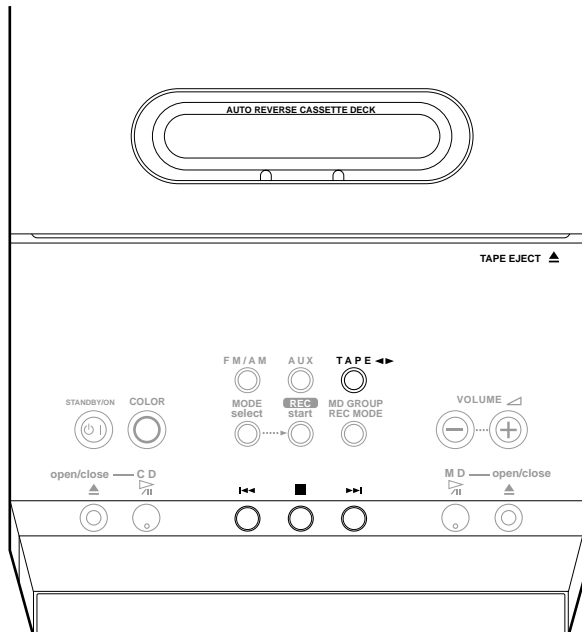



## Playing Back a Tape

You can play back type I, II, and IV tapes.

### 1 Press TAPE EJECT ▲.

The cassette holder opens.

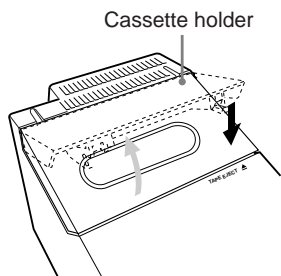

### 2 Put a cassette in with the exposed part of the tape in front.

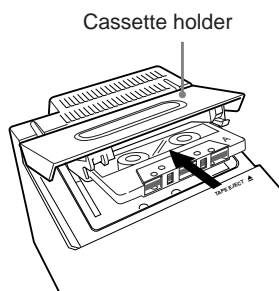

### 3 Close the cassette holder gently.

### 4 Press TAPE ◀▶.

The unit automatically turns on and the tape play starts.

- Each time you press the button, the tape direction changes as follows:

- ▶▶ : plays the front side.
- ◀◀ : plays the reverse side.

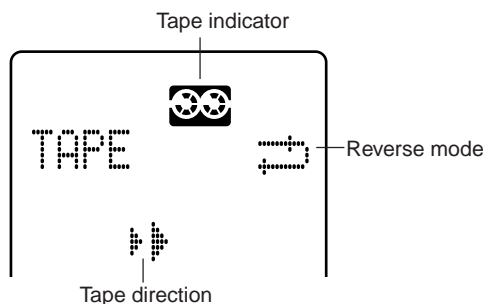

When the tape plays to the end, the deck automatically stops if the reverse mode is set to ▶▶ or ◀◀. (See "To play both sides — Reverse Mode" to the right.)

To stop during play, press ■.

To fast-wind to the left or to the right, press ◀◀ or ▶▶.

To remove the cassette, press TAPE EJECT ▲.



DO NOT press TAPE EJECT ▲ during tape play.

### To play both sides — Reverse Mode

You can set the deck to play just one side of a tape, both sides once, or both sides continuously.

#### On the remote control ONLY:

Press REV. MODE.

- Each time you press the button, the reverse mode changes as follows:
  - ▶▶ : To only play back one side (front or reverse).
  - ▶◀ : To play back the front and reverse sides once.
  - ◀▶ : To play back both front and reverse sides continuously.

### To check the clock time while playing back a tape

#### On the remote control ONLY:

Press DISPLAY/CHARA.

- Each time you press the button, the source indications and the clock time alternate on the display.



The use of the C-120 or thinner tape is not recommended, since characteristic deterioration may occur and this tape easily jams in the pinchrollers and the capstans.

# Recording on MDs

The buttons emphasized in the illustration below are used and explained in this section (pages 30 to 34.)  
**For recording operations, mainly use the buttons on the main unit.**

Main unit (Top view)

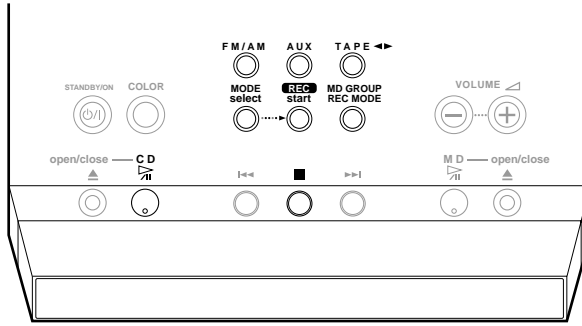

Remote control

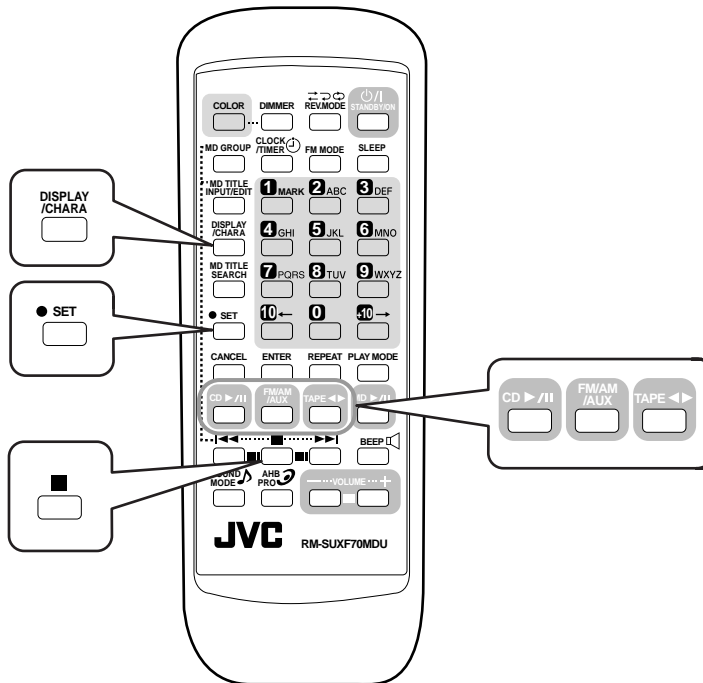

## Before You Start Recording on an MD

- It may be unlawful to record or play back copyrighted material without the consent of the copyright owner.
- When you record onto a partially recorded MD, its contents are not erased or overwritten. The recording starts from the point following the last recorded track of the MD. If you want to record on such an MD from the beginning, you have to erase its contents first (see “Erasing All Tracks — ALL ERASE” on page 52.)
- When an MD is fully recorded, recording will stop automatically.
- The recording level is automatically set correctly, so it is not affected by the VOLUME control. Thus, during recording you can adjust the sound you are actually listening to without affecting the recording level.
- While recording, you can hear sound mode effect and/or the Active Hyper Bass Pro effect through the speakers or headphones. However, the sound is recorded without these effects (see pages 12.)
- You can make a digital-to-digital recording from a CD onto an MD. When selecting FM, AM, TAPE or AUX as the source, you can make an analog-to-digital recording only.
- You cannot record more than 254 tracks onto an MD, though there is a still enough remaining recording time on it.
- The display turns red while recording is performed.

### About the track marks

When playing an MD, you can move among the tracks. You can do this because there is a mark recorded at the beginning of each track enabling you to locate the track. This mark is called a “**track mark**” and the portion between two adjacent track marks is called a “**track**.”

- **When recording from the CD player**, a track mark is recorded automatically at the beginning of each track.
- **When recording from an analog source such as FM/AM broadcasts**, no track mark is recorded on the MD. This means that, when playing this MD, the MD recorder will regard the entire recording as one track (track 1.) You will not be able to select directly a song or navigate through songs.

However, if there is a blank of 3 seconds or more, the MD recorder will consider it as a blank separating 2 tracks and consequently put a track mark.

**To put a track mark manually while recording an analog source**, press SET on the remote control at the place you want to put a track mark.

**To add a track mark after recording is over**, you can use the DIVIDE function (see page 50.)

### To avoid erasing important recordings

The recordable MD has an erasure prevention tab so that important recordings are not accidentally erased. When you finish recording or editing, slide to open the erasure prevention tab on the cartridge side surface. New recording or editing is now no longer possible. (If you try to do, “DISC PROTECTED” appears on the display.)

To do re-recording or editing, return the tab to the closed position.

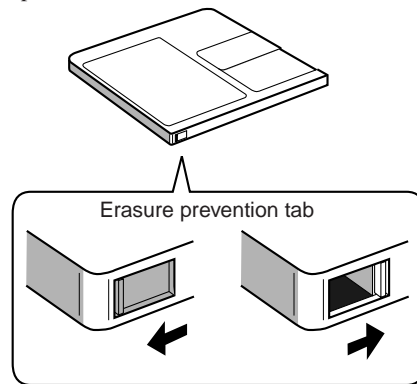

Recording/Editing  
possible

Disc protected:  
Recording/Editing  
not possible



**If “PLAYBACK DISC” appears on the display when you try to record on an MD**

The MD is only for playback use, not for recording.

### Stereo Long-Hour Recording (MDLP)

On conventional MD recorders, 2 times long-hour recording on MDs has been possible only in monaural sound, but this unit allows for 2 times or 4 times long-hour recording without losing stereo sound.

With this feature, songs (tracks) can be recorded on a single MD using different recording length modes — SP: Standard Play, LP2: 2 Times Long Play, LP4: 4 Times Long Play.

**SP:** Signifies standard-hour stereo recording.

The number of hours usable for recording is the same as shown on the package of the MD.

**LP2:** Signifies 2 times long-hour stereo recording.

The number of hours usable for recording is twice as long as shown on the package of the MD.

**LP4:** Signifies 4 times long-hour stereo recording.

The number of hours usable for recording is 4 times as long as shown on the package of the MD.

#### REMEMBER to check the remaining recording time of MDs before starting recording

The remaining recording time of MDs will be calculated and be shown, based on the recording length mode (SP/LP2/LP4) currently selected.

Before starting recording or using the Recording Timer, check the recording time remaining on the MD for each recording length mode (SP/LP2/LP4) and select the optimum recording length mode.

#### To check the remaining recording time

- 1 Insert an MD to record on.
- 2 Press MD ►/II, then ■ to select “MD” as the source.
- 3 Press DISPLAY/CHARA repeatedly until the remaining recording time (“REM”) appears on the display.

#### Precautions for performing long-hour stereo recording

After having made long-hour stereo recordings on this unit, pay attention to the following:

- Songs (tracks) recorded in 2 times or 4 times long-hour recording mode can only be played back on the equipment provided with MDLP, compatible with a long-hour stereo recording function; otherwise, “LP:” is displayed before a title and playback proceeds without sounds.
- When editing songs (tracks) on an MD, you cannot join (JOIN) songs (tracks) recorded in different recording length modes (SP/LP2/LP4).



#### More about MDLP

- You cannot make a long-hour monaural recording using this unit.
- Sound quality will decrease as the recording length mode changes to LP2 (little) and LP4 (much). To obtain the best sound quality, it is recommended to use the SP mode when recording.

### About High-Speed Recording

There are some restrictions to observe for high-speed recording (x2 speed recording: two times as quick as normal speed recording, x4 speed recording: four times as quick as normal speed recording) to protect copyrights. (HCMS: see page 63.)

This unit is so designed that a song (track) recorded from a CD using high-speed recording cannot be re-recorded until 74 minutes elapse after the previous recording started.

If you try to re-record the same song (track) within the 74 minutes, recording is canceled and “HCMS CANNOT COPY” appears on the display as a warning.

The remaining time required until re-recording will then appear on the display.

If this happens, press ■ after the remaining time appears.

REMEMBER if you are trying to record a program including the same song (track) twice using high-speed recording, recording will stop at the beginning of the 2nd recording of the same song (track). (“HCMS CANNOT COPY” will appear on the display.)



#### During high-speed recording

You cannot listen to any source, and therefore, cannot adjust the volume level. (“CANNOT LISTEN!” will appear if you try to do.)



#### About x4 speed recording

You can select x4 speed recording only when you select SP as recording length mode.

**Before recording on an MD**

You can form a new group easily while recording — “GROUP ON” (initial setting at factory).

To cancel group recording, press MD GROUP REC MODE so that “GROUP OFF” appears on the display. (The GROUP indicator goes off.)

- Each time you press the button, group recording turns on (GROUP ON) and off (GROUP OFF).

GROUP ON ↔ GROUP OFF

When the GROUP indicator is lit (GROUP ON), all the recorded tracks at a time will form a new group.

**Recording FM/AM Broadcasts**

You have three methods (MODE 1/5 – 3/5) to record an FM or AM broadcast onto an MD.

Recording mode	Recording length mode	Recording Speed
MODE 1/5	SP	NORMAL SPEED REC
MODE 2/5	LP2	NORMAL SPEED REC
MODE 3/5	LP4	NORMAL SPEED REC

As for MODE 4/5 and 5/5, see page 37.

**On the main unit ONLY:**

- 1 Insert a recordable MD into the MD loading slot.
- 2 Tune into a station you want.
  - For more detailed operations, see pages 14 to 16.
- 3 Press MODE select to select a recording mode (MODE 1/5 – MODE 3/5) you want.

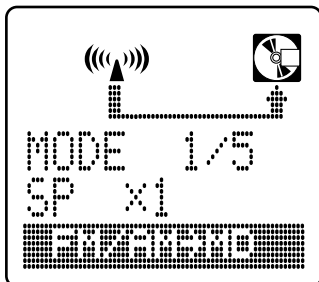

Ex.: When recording with MODE 1/5

- 4 Press REC start.
 

The recording starts.

To stop recording, press ■.

“UTOCwriting” appears on the display for a while.

To put a track mark manually while recording, press SET on the remote control at the place you want.

**To check the remaining time while recording the tuner onto an MD****On the remote control ONLY:**

Press DISPLAY/CHARA.

- Each time you press the button, the recording indications, remaining time, the current track number of the MD, and clock time appear in sequence.

**Recording CD — CD Synchronized Recording**

You have seven methods (MODE 1/15 – 7/15) to record a CD onto an MD.

Using these synchronized recording methods, you can start and stop CD play and MD recording at the same time.

Recording mode	Recording length mode	Recording Speed
MODE 1/15	SP	NORMAL SPEED REC
MODE 2/15	LP2	NORMAL SPEED REC
MODE 3/15	LP4	NORMAL SPEED REC
MODE 4/15	SP	HIGH SPEED REC (x2)
MODE 5/15	LP2	HIGH SPEED REC (x2)
MODE 6/15	LP4	HIGH SPEED REC (x2)
MODE 7/15	SP	HIGH SPEED REC (x4)

As for MODE 8/15 and 9/15, see page 37.

As for MODE 10/15 to 15/15, see page 39.

**On the main unit ONLY:**

- 1 Insert a recordable MD into the MD loading slot.
- 2 Prepare a CD.
  - After placing a CD, press CD ► / ||, then ■ before going to the next step.
  - You can make a program (see page 19) or select Random play mode (see page 20) if you want.
- 3 Press MODE select to select a recording mode (MODE 1/15 – MODE 7/15) you want.

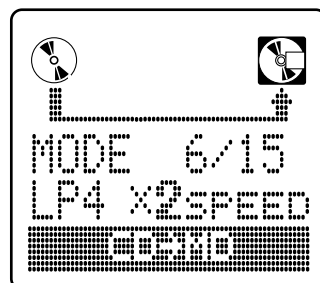

Ex.: When recording with MODE 6/15

**4 Press REC start.**

Both the CD play and the recording start.

After the recording, both the CD player and the MD recorder stop automatically.

**To stop recording**, press ■.

“UTOCwriting” appears on the display for a while.

**To record a single track during play or pause**

While playing back or pausing a CD track you want to record, perform steps **3** and **4**.

The playback of that CD track is stopped, and the same track starts playing from the beginning again. This time, the MD recorder starts recording the CD track.

- After the track is recorded, both the CD player and the MD recorder stop automatically.

**To check the remaining time while recording CD onto an MD**

**On the remote control ONLY:**

Press **DISPLAY/CHARA**.

- Each time you press the button, the recording indications, remaining time, the current track number of the CD and the MD, and clock time appear in sequence.



**When you want to record on both an MD and a tape**

See “Recording CD onto an MD and a Tape — CD Synchronized Recording” on page 39.

**Recording Tape — Tape Synchronized Recording**

You have six methods (MODE 1/6 – 6/6) to record from a tape onto an MD.

Using these synchronized recording methods, you can start and stop tape play and MD recording at the same time.

Recording mode	Reverse Mode	Recording length mode	Recording Speed
MODE 1/6	↺↻	SP	NORMAL SPEED REC
MODE 2/6	↻↺	SP	NORMAL SPEED REC
MODE 3/6	↻↺	LP2	NORMAL SPEED REC
MODE 4/6	↻↺	LP2	NORMAL SPEED REC
MODE 5/6	↻↺	LP4	NORMAL SPEED REC
MODE 6/6	↻↺	LP4	NORMAL SPEED REC

**On the main unit ONLY:**

**1 Insert a recordable MD into the MD loading slot.**

- If the MD playback starts, press ■ to stop it.

**2 Prepare a source tape.**

After inserting a tape, press TAPE ◀▶, then ■ before going to the next step.

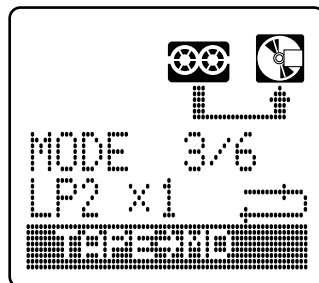
**3 Press MODE select to select a recording mode (MODE 1/6 – MODE 6/6) you want.**

Ex.: When recording with MODE 3/6

**4 Press REC start.**

Both the tape play and the recording start.

After the recording, both the cassette deck and the MD recorder stop automatically.

**To stop recording**, press ■.

“UTOCwriting” appears on the display for a while.

**To put a track mark manually while recording**, press SET on the remote control at the place you want.

**To check the remaining time while recording tape onto an MD**

**On the remote control ONLY:**

Press **DISPLAY/CHARA**.

- Each time you press the button, the recording indications, remaining time, the current track number of the MD, and clock time appear in sequence.

## Recording the External Equipment — Sound Synchronized Recording

With this recording method, you can start recording automatically when the source sound comes into this unit through the LINE IN (AUX) jacks.

Sound synchronized Recording will stop automatically if no sound comes into for more than 30 seconds.

You have three methods (MODE 1/5 – 3/5) to record from external equipment onto an MD.

Recording mode	Recording length mode	Recording Speed
MODE 1/5	SP	NORMAL SPEED REC
MODE 2/5	LP2	NORMAL SPEED REC
MODE 3/5	LP4	NORMAL SPEED REC

As for MODE 4/5 and 5/5, see page 38.

### On the main unit ONLY:

- 1** Insert a recordable MD into the MD loading slot.
  - If the MD playback starts, press ■ to stop it.
- 2** Press AUX.  
The source is changed to “AUX.”
- 3** Press MODE select to select a recording mode (MODE 1/5 – MODE 3/5) you want.

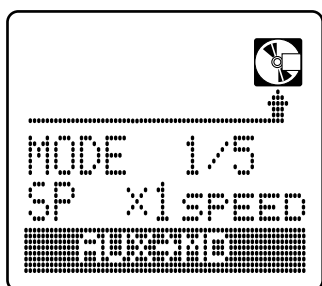

Ex.: When recording with MODE 1/5

- 4** Press REC start.  
“AUX Ready” appears on the display.
- 5** Start playback on the external equipment.  
The recording starts automatically when the sound comes into this unit.

To stop recording, press ■.

“UTOCwriting” appears on the display for a while.

To put a track mark manually while recording, press SET on the remote control at the place you want.

To check the remaining time while recording external equipment onto an MD

### On the remote control ONLY:

Press DISPLAY/CHARA.

- Each time you press the button, the recording indications, remaining time, the current track number of the MD, and clock time appear in sequence.

# Recording on Tapes

The buttons emphasized in the illustration below are used and explained in this section (pages 36 to 39.)  
**For recording operations, mainly use the buttons on the main unit.**

Main unit (Top view)

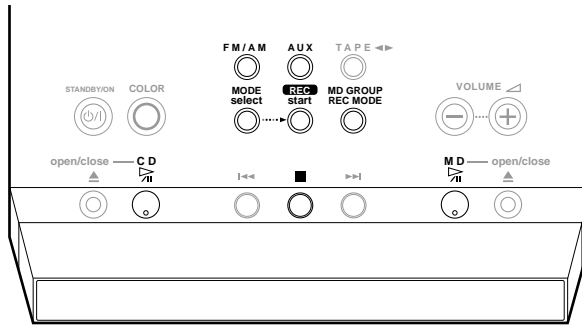

Remote control

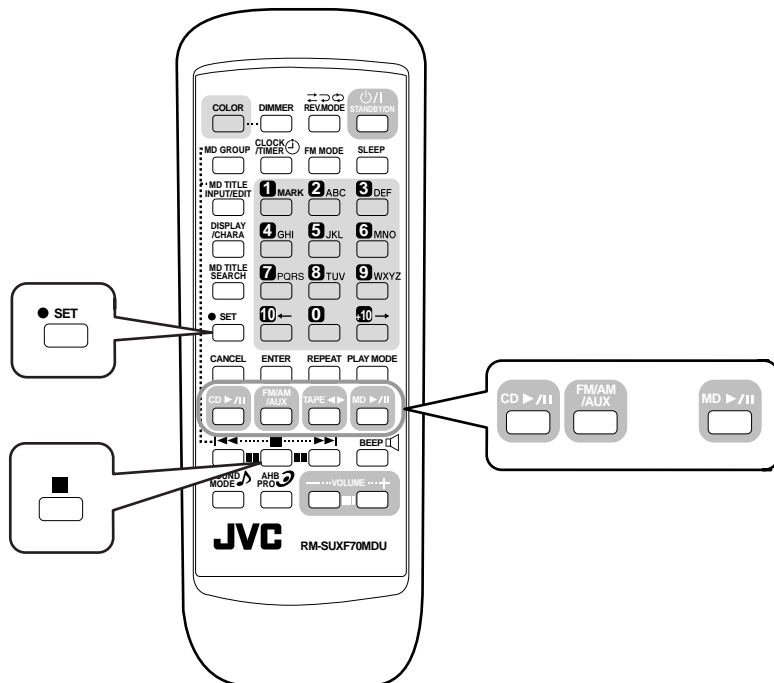



## Before You Start Recording on a Tape

- It may be unlawful to record or play back copyrighted material without the consent of the copyright owner.
- The recording level is automatically set correctly, so it is not affected by the VOLUME control. Thus, during recording you can adjust the sound you are actually listening to without affecting the recording level.
- While recording, you can hear sound mode effect and/or the Active Hyper Bass Pro effect through the speakers or headphones. However, the sound is recorded without these effects (see pages 12.)
- If recordings you have made have excessive noise or static, the unit may be too close to a TV. Place the unit away from the TV.
- You can use type I tape for recording.

### To protect your recordings

Cassettes have two small tabs on the back to protect unexpected erasure or recording.

To protect your recording, remove these tabs.

To re-record on a protected tape, cover the holes with adhesive tape.



The use of the C-120 or thinner tape is not recommended, since characteristic deterioration may occur and this tape easily jams in the pinchrollers and the capstans.

### To keep the best recording and playback sound quality

If the heads, capstans, and pinch rollers of the cassette deck become dirty, the following will occur:

- Loss of sound quality
- Discontinuous sound
- Fading
- Incomplete erasure
- Difficulty in recording

### To clean the heads, capstans, and pinch rollers

Use a cotton swab moistened with alcohol.

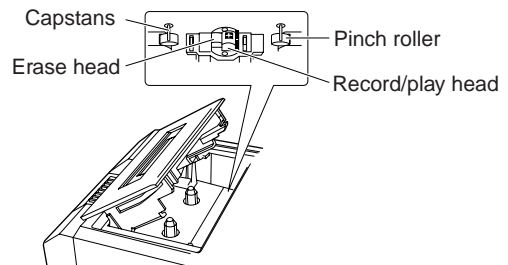

### To demagnetize the head

Turn off the unit, and use a head demagnetizer (available at electronics and audio shops).



### At the start and end of cassette tapes

There is leader tape which cannot be recorded onto. Thus, when recording CDs or radio broadcasts, wind the leader tape first to ensure that the recording will be made without any music part lost.

## Recording FM/AM Broadcasts

You have two methods (MODE 4/5 and 5/5) to record an FM or AM broadcast onto a tape.

Recording mode	Reverse mode
MODE 4/5	
MODE 5/5	

As for MODE 1/5 to 3/5, see page 32.

### On the main unit ONLY:

- 1 Insert a recordable cassette into the cassette holder.
- 2 Tune into a station you want.
  - For more detailed operations, see pages 14 to 16.
- 3 Press MODE select to select a recording mode (MODE 4/5 or MODE 5/5) you want.

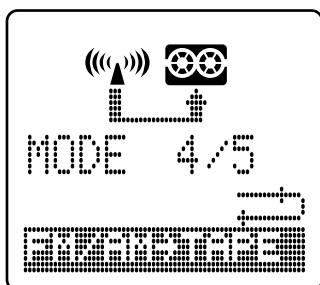

Ex.: When recording with MODE 4/5

- 4 Press REC start.
  - The recording starts.

To stop recording, press ■.

### To check the clock time while recording the tuner onto a tape

#### On the remote control ONLY:

Press DISPLAY/CHARA.

- Each time you press the button, the recording indications and the clock time alternate on the display.

## Recording CD — CD Synchronized Recording

You have two methods (MODE 8/15 and 9/15) to record a CD onto a tape.

Using these synchronized recording methods, you can start and stop CD play and tape recording at the same time.

Recording mode	Reverse mode
MODE 8/15	
MODE 9/15	

As for MODE 1/15 to 7/15, see page 32.

As for MODE 10/15 to 15/15, see page 39.

### On the main unit ONLY:

- 1 Insert a recordable cassette into the cassette holder.
- 2 Prepare a CD.
  - After placing a CD, press CD ► / II, then ■ before going to the next step.
  - You can make a program (see page 19) or select Random play mode (see page 20) if you want.
- 3 Press MODE select to select a recording mode (MODE 8/15 or MODE 9/15) you want.

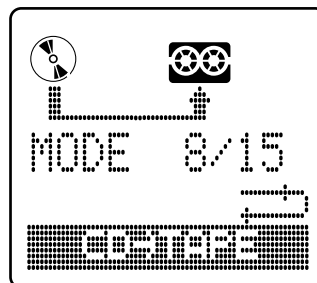

Ex.: When recording with MODE 8/15

- 4 Press REC start.
  - Both the CD play and the recording start.

After the recording, both the CD player and the cassette deck stop automatically.

To stop recording, press ■.

CD play stops first then, after 4 records, the recording stops.

### To record a single track during play or pause

While playing back or pausing a CD track you want to record, perform steps 3 and 4.

The playback of that CD track is stopped, and the same track starts playing from the beginning again. This time, the cassette deck starts recording the CD track.

- After the track is recorded, both the CD player and the cassette deck stop automatically.

### To check the clock time while recording CD onto a tape

#### On the remote control ONLY:

Press DISPLAY/CHARA.

- Each time you press the button, the recording indications and the clock time alternate on the display.

## Recording MD — MD Synchronized Recording

You have two methods (MODE 1/2 and 2/2) to record an MD onto a tape.

Using these synchronized recording methods, you can start and stop MD play and tape recording at the same time.

Recording mode	Reverse mode
MODE 1/2	
MODE 2/2	

### On the main unit ONLY:

- 1 Insert a recordable cassette into the cassette holder.
- 2 Prepare an MD.
  - After inserting an MD, press MD ► / ■, then ■ before going to the next step.
  - You can make a program (see page 24) or select Random play mode (see page 25) or Group play mode (see page 25) if you want.
- 3 Press MODE select to select a recording mode (MODE 1/2 or MODE 2/2) you want.

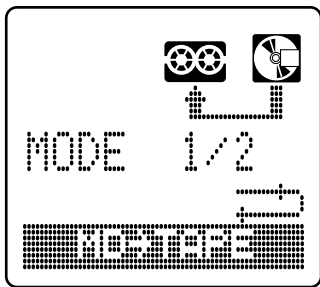

Ex.: When recording with MODE 1/2

### 4 Press REC start.

Both the MD play and the recording start.

After the recording, both the MD and the cassette deck stop automatically.

### To stop recording, press ■.

MD play stops first, then, after 4 seconds, the recording stops.

### To check the clock time while recording MD onto a tape

#### On the remote control ONLY:

Press DISPLAY/CHARA.

- Each time you press the button, the recording indications and the clock time alternate on the display.

## Recording the External Equipment

You have two methods (MODE 4/5 and 5/5) to record from external equipment onto a tape.

Recording mode	Reverse mode
MODE 4/5	
MODE 5/5	

As for MODE 1/5 to 3/5, see page 34.

### On the main unit ONLY:

- 1 Insert a recordable cassette into cassette holder.
- 2 Press AUX.
 

The source is changed to "AUX."
- 3 Press MODE select to select a recording mode (MODE 4/5 or MODE 5/5) you want.

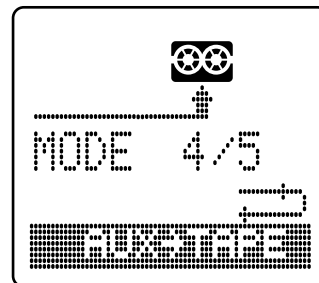

Ex.: When recording with MODE 4/5

### 4 Press REC start.

The recording starts.

### 5 Start playback on the external equipment.

To stop recording, press ■.

### To check the clock time while recording the external equipment onto a tape

#### On the remote control ONLY:

Press DISPLAY/CHARA.

- Each time you press the button, the recording indications and the clock time alternate on the display.

## Recording CD onto an MD and a Tape — CD Synchronized Recording

You have six methods (MODE 10/15 – 15/15) to record a CD onto an MD and a tape at the same time.

Using these synchronized recording methods, you can start and stop CD play, MD and tape recordings at the same time.

Recording mode	Reverse Mode	Recording Speed	Recording length mode
MODE 10/15	↔	NORMAL SPEED REC	SP
MODE 11/15	→	NORMAL SPEED REC	SP
MODE 12/15	↔	NORMAL SPEED REC	LP2
MODE 13/15	→	NORMAL SPEED REC	LP2
MODE 14/15	↔	NORMAL SPEED REC	LP4
MODE 15/15	→	NORMAL SPEED REC	LP4

As for MODE 1/15 to 7/15, see page 32.

As for MODE 8/15 and 9/15, see page 37.

### On the main unit ONLY:

**1** Insert a recordable MD into the MD loading slot and a recordable cassette into the cassette holder.

**2** Prepare a CD.

- After placing a CD, press CD ► / ||, then ■ before going to the next step.
- You can make a program (see page 19) or select Random play mode (see page 20) if you want.

**3** Press MODE select to select a recording mode (MODE 10/15 – MODE 15/15) you want.

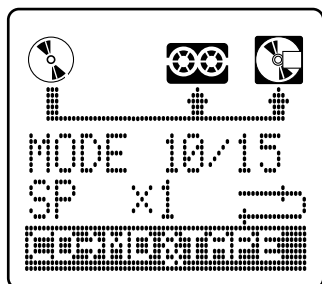

Ex.: When recording with MODE 10/15

**4** Press REC start.

CD play and the recording start.

After the recording, the CD, MD recorder and the cassette deck stop automatically.

To stop recording, press ■.

“UTOCwriting” appears on the display for a while.

### To record a single track during play or pause

While playing back or pausing a CD track you want to record, perform steps **3** and **4**.

The playback of that CD track is stopped, and the same track starts playing from the beginning again. This time, the MD recorder and cassette deck start recording the CD track.

- After the track is recorded, all the CD player, the MD recorder and cassette deck stop automatically.

### To check the remaining time while recording CD onto an MD and a tape

#### On the remote control ONLY:

Press DISPLAY/CHARA.

- Each time you press the button, the recording indications, remaining time of the MD, the current track number of the CD and the MD, and clock time appear in sequence.

The buttons emphasized in the illustration below are used and explained in this section (pages 41 to 47.)

## About MD Group

MD group helps you to play or edit many tracks easily. You can form up to 99 groups. (A single track can form a group.)

You can do that following using groups.

Group Play: See page 25.

Assigning the Group title: See page 54.

Editing MD Groups: See this section.

## Remote control

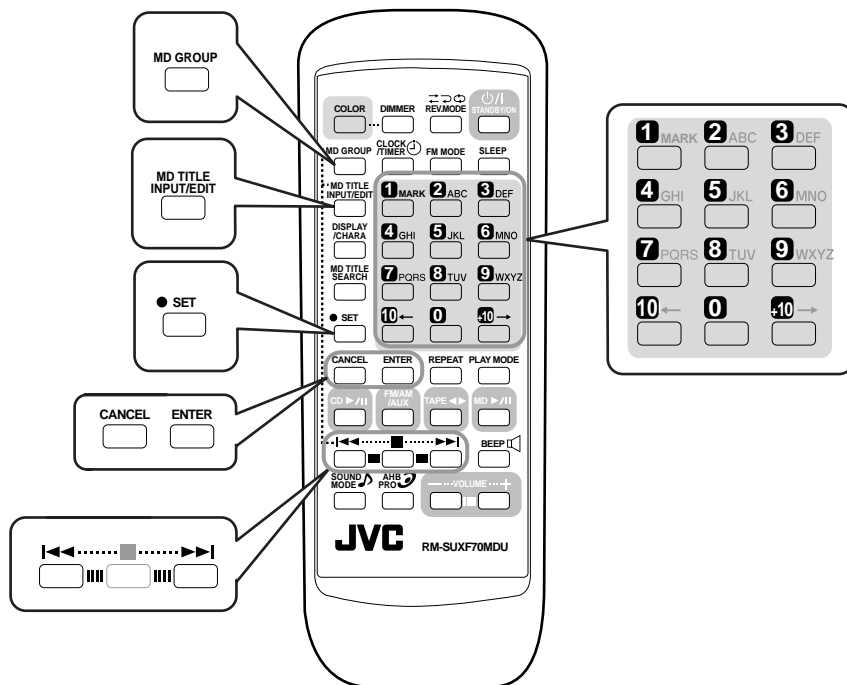

## Guidance — MD Group Functions

To add to the conventional MD Editing functions (called the track editing functions in this unit), MD Group functions helps you to classify the tracks by making groups on your MD.

### Classifying the tracks on an MD

MDLP enables you to record more tracks on a single MD than usual. So, there are many tracks which have been recorded from the various sources — CD, FM, and so on — on your MD.

In that case, if you can classify the tracks by source, by album, or by artist, the playback of your favorite songs becomes much easier.

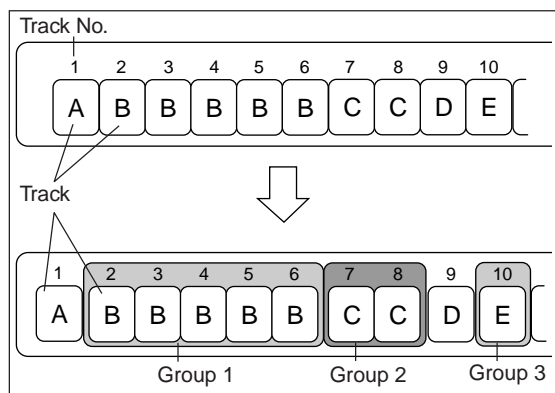

In the figure above, as an example, there are 5 different genres (from A to E) of tracks on the MD. Using MD Group functions, you can form a group by genre B tracks as Group 1.

By forming groups on the MD, you can classify the tracks by each genre — the album title, the artist, etc. You can also assign a name to each group (see page 53.)

### Using MD Group Functions

MD Group functions consists of Group play, Group recording and Group editing.

- **Group play (see page 25):**

You can play back and repeat the desired group without making a program: For example, you can play back repeatedly the genre B tracks by selecting Group 1 in the left figure.

- **Group recording (see page 32):**

You can form a group while tracks are being recorded.

- **Group editing:**

You can edit the groups using the following functions:

- Forming a group (FORM GR)
- Adding a track to a group (ENTRY GR)
- Dividing a group (DIVIDE GR)
- Joining two groups (JOIN GR)
- Moving a group (MOVE GR)
- Ungrouping tracks (UNGROUP)
- Dissolving all groups (UNGR ALL)
- Erasing tracks in a group (ERASE GR)

### How to Make Up Groups

You can make up groups using two methods: Forming-a-group function and Group recording function.

- **Forming-a-group function — FORM GR:**

Select this when you want to make groups after recording.

- **Group recording function:**

Select this when you want to record and group tracks at the same time.

## Introducing MD Group Editing

MD tracks can be grouped in many ways. The MD group editing includes the following functions.

### Forming a group (FORM GR) : Page 43

This function forms a series of tracks or a track in a new group.

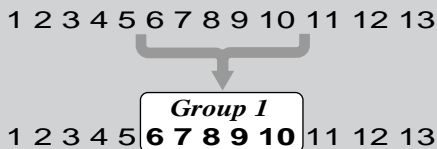

### Adding a track to a group (ENTRY GR) : Page 44

This function enters the selected track into a group.

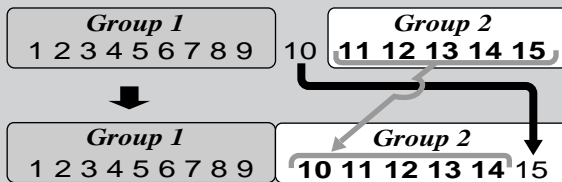

### Dividing a group (DIVIDE GR) : Page 44

This function divides a group containing plural tracks.

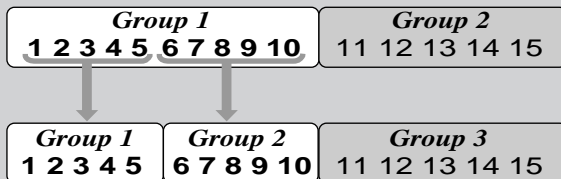

### Joining two groups (JOIN GR) : Page 45

This function joins two adjacent groups into a single group.

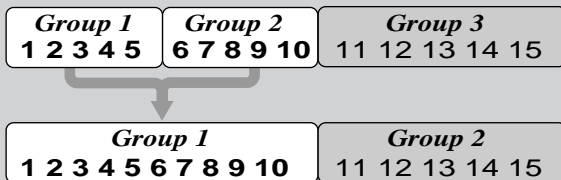

### Moving a group (MOVE GR) : Page 46

This function moves the selected group by reordering the group and track numbers.

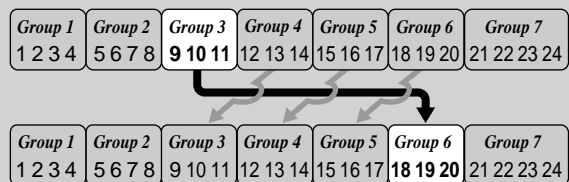

### Ungrouping tracks (UNGROUP) : Page 46

This function dissolves a group.

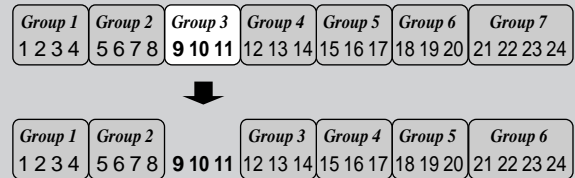

### Dissolving all groups (UNGR ALL) : Page 47

This function dissolves all the groups.

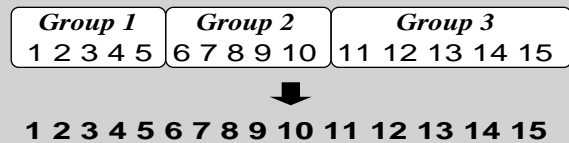

### Erasing tracks in a group (ERASE GR) : Page 47

This function erases the tracks in the selected group.

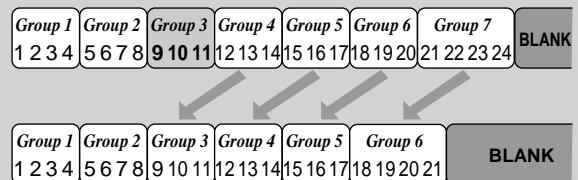

If "PLAYBACK DISC" or "DISC PROTECTED" appears on the display when you try to edit an MD You cannot edit such MDs (see page 30.)

## Forming a Group — FORM GR

This function allows you to form a group from a series of tracks which do not belong to the other groups. You can form a group from a single track.

Once a new group is formed, the other groups are renumbered.

- You can form up to 99 groups on a single MD.
- To stop any time during editing process, press MD TITLE INPUT/EDIT.

### On the remote control ONLY:

**1** Insert an MD to edit.

**2** Press MD TITLE INPUT/EDIT repeatedly while pressing MD GROUP to select “FORM GR?”  
The source changes to “MD.”



- Each time you press MD TITLE INPUT/EDIT while pressing MD GROUP, the group editing mode changes as follows:

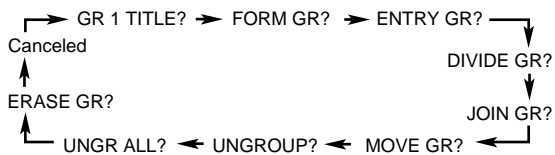

- If you want to stop this editing process, press CANCEL.

**3** Press SET.

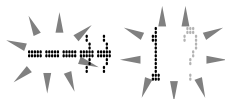

**4** Press ►► or ◀◀ to select the first track of a new group.

- You can select the track using number buttons. In this case, the selected track starts playback repeatedly.

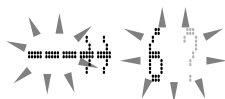

- **During playback:**  
The selected track starts playback repeatedly.

**5** Press SET.

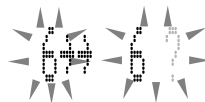

- “GROUP TRACK” appears when the track is already in a group.
- To cancel the setting, press CANCEL, then repeat step 4.

**6** Press ►► or ◀◀ to select the last track of a new group.

- You can select the track using number buttons. In this case, the selected track starts playback repeatedly.

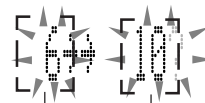

The first track    The last track

- **During playback:**  
The selected track starts playback repeatedly.
- “GROUP TRACK” appears when the track is already in a group.

**7** Press SET.

“<FORM GR>” appears on the display.

- To cancel the setting, press CANCEL, then repeat step 4.

**8** Press ENTER to finish the editing procedure.

“EDITING” then “UTOwriting” appears on the display while the editing you have made is being recorded on the MD.

**To ungroup the tracks,** see the UNGROUP function on page 46.

**To form a group while recording,** see “Before recording on an MD” on page 32.



## Adding a Track to a Group — ENTRY GR

This function allows you to enter a track into a group. The track will be added as the last track in the selected group. The track numbers will be renumbered.

- To stop any time during editing process, press MD TITLE INPUT/EDIT.

### On the remote control ONLY:

**1** Insert an MD to edit.

**2** Press MD TITLE INPUT/EDIT repeatedly while pressing MD GROUP to select “ENTRY GR?” The source changes to “MD.”



- Each time you press MD TITLE INPUT/EDIT while pressing MD GROUP, the group editing mode changes as follows:

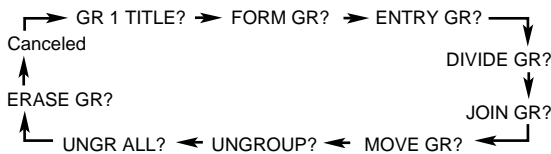

- If you want to stop this editing process, press CANCEL.

**3** Press SET.

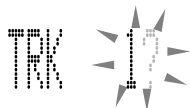

- During playback:**  
The current track number starts flashing.

**4** Press ►► or ◀◀ to select a track you want to add to a group.

- You can select the track using number buttons. In this case, the selected track starts playback repeatedly.



- During playback:**  
The selected track starts playback repeatedly.

**5** Press SET.

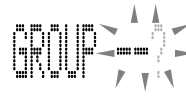

- To cancel the setting, press CANCEL, then repeat step 4.

**6** Press ►► or ◀◀ to select a group.



- During playback:**  
The tracks in the selected group is played back repeatedly.

**7** Press SET.

“<ENTRY GR>” appears on the display.

- If the track is already in a group, “CANNOT ENTRY!” appears on the display.
- To cancel the setting, press CANCEL, then repeat step 4.

**8** Press ENTER to finish the editing procedure.

“EDITING” then “UTOwriting” appears on the display while the editing you have made is being recorded on the MD.

## Dividing a Group — DIVIDE GR

This function allows you to divide one group into two separate groups.

You cannot divide the group containing a single track. When the original group has a title, two separate groups are reassigned the same title as the original group. Once a new group is divided, the other groups are renumbered.

- To stop any time during editing process, press MD TITLE INPUT/EDIT.

### On the remote control ONLY:

**1** Insert an MD to edit.

- 2** Press MD TITLE INPUT/EDIT repeatedly while pressing MD GROUP to select “DIVIDE GR?”  
The source changes to “MD.”

- Each time you press MD TITLE INPUT/EDIT while pressing MD GROUP, the group editing mode changes as follows:

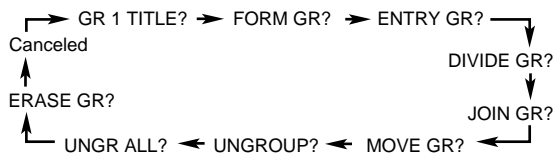

- If you want to stop this editing process, press CANCEL.

- 3** Press SET.

- 4** Press ►► or ◀◀ to select the track as the dividing point.

- You can select the track using number buttons. In this case, the selected track starts playback repeatedly.
- The track selected in this step will be the first track in the divided group.
- You cannot select the first track in a group as the dividing point.

- During playback:**  
The selected track starts playback repeatedly.

- 5** Press SET.

- “<DIVIDE GR>” appears on the display.  
To cancel the setting, press CANCEL, then repeat step 4.

- 6** Press ENTER to finish the editing procedure.  
“EDITING” then “UTOCwriting” appears on the display while the editing you have made is being recorded on the MD.

To join the divided groups, see the JOIN GR function to the right.

## Joining Two Groups — JOIN GR

This function allows you to join two adjacent groups into a single group.

When the groups have each title, the title of the preceding group is reassigned to the joined group.

Once two groups are joined, the other groups are renumbered.

- To stop any time during editing process, press MD TITLE INPUT/EDIT.

### On the remote control ONLY:

- 1** Insert an MD to edit.

- 2** Press MD TITLE INPUT/EDIT repeatedly while pressing MD GROUP to select “JOIN GR?”  
The source changes to “MD.”

- Each time you press MD TITLE INPUT/EDIT while pressing MD GROUP, the group editing mode changes as follows:

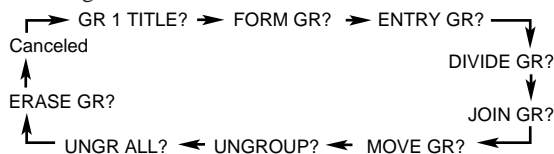

- If you want to stop this editing process, press CANCEL.

- 3** Press SET.

- 4** Press ►► or ◀◀ to select the two adjacent groups to be joined.

- During playback:**  
The tracks in the selected group are played back repeatedly.

- 5** Press SET.

- “<JOIN GR>” appears on the display.  
You cannot join two groups if ungrouped track is in between the two groups. “CANNOT JOIN” appears on the display.  
To cancel the setting, press CANCEL, then repeat step 4.

- 6** Press ENTER to finish the editing procedure.  
“EDITING” then “UTOCwriting” appears on the display while the editing you have made is being recorded on the MD.

To divide the joined group, see the DIVIDE GR function on page 44.

## Moving a Group — MOVE GR

This function allows you to move a group.  
Once a group is moved, the tracks and the other groups are renumbered.

- To stop any time during editing process, press MD TITLE INPUT/EDIT.

### On the remote control ONLY:

- 1 Insert an MD to edit.
- 2 Press MD TITLE INPUT/EDIT repeatedly while pressing MD GROUP to select “MOVE GR?”  
The source changes to “MD.”

- Each time you press MD TITLE INPUT/EDIT while pressing MD GROUP, the group editing mode changes as follows:

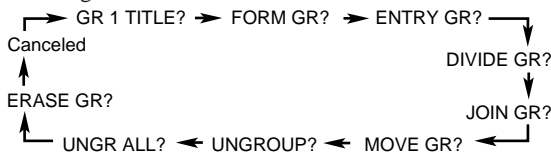

- If you want to stop this editing process, press CANCEL.

- 3 Press SET.

- 4 Press ►► or ◀◀ to select a group you want to move.

- During playback:**  
The tracks in the selected group are played back repeatedly.

- 5 Press SET.

- To cancel the setting, press CANCEL, then repeat step 4.

- 6 Press ►► or ◀◀ to select the position where you want to move the group.

- During playback:**  
The tracks in the selected group are played back repeatedly.
- To cancel the setting, press CANCEL, then repeat step 4.

- 7 Press SET.  
“<MOVE GR>” appears on the display.  
To cancel the setting, press CANCEL, then repeat step 4.

- 8 Press ENTER to finish the editing procedure.  
“EDITING” then “UTOCwriting” appears on the display while the editing you have made is being recorded on the MD.

## Ungrouping Tracks — UNGROUP

This function allows you to dissolve a single group.  
You cannot erase the tracks using this function.  
Once tracks are ungrouped, the other groups are renumbered.

- To stop any time during editing process, press MD TITLE INPUT/EDIT.

### On the remote control ONLY:

- 1 Insert an MD to edit.
- 2 Press MD TITLE INPUT/EDIT repeatedly while pressing MD GROUP to select “UNGROUP?”  
The source changes to “MD.”

- Each time you press MD TITLE INPUT/EDIT while pressing MD GROUP, the group editing mode changes as follows:

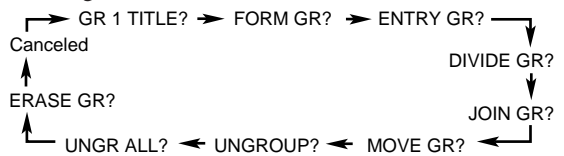

- If you want to stop this editing process, press CANCEL.

- 3 Press SET.

- 4 Press ►► or ◀◀ to select a group to be ungrouped.

- During playback:**  
The tracks in the selected group are played back repeatedly.

- 5 Press SET.  
“<UNGROUP>” appears on the display.  
To cancel the setting, press CANCEL, then repeat step 4.

- 6 Press ENTER to finish the editing procedure.  
“EDITING” then “UTOCwriting” appears on the display while the editing you have made is being recorded on the MD.

## Dissolving All Groups — UNGR ALL

This function allows you to dissolve all the groups. You cannot erase the tracks using this function.

- To stop any time during editing process, press MD TITLE INPUT/EDIT.

### On the remote control ONLY:

- 1 Insert an MD to edit.
- 2 Press MD TITLE INPUT/EDIT repeatedly while pressing MD GROUP to select “UNGR ALL?”  
The source changes to “MD.”

- Each time you press MD TITLE INPUT/EDIT while pressing MD GROUP, the group editing mode changes as follows:

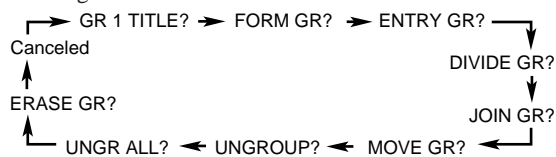

- If you want to stop this editing process, press CANCEL.

- 3 Press SET.  
“<UNGR ALL>” appears on the display.

- 4 Press ENTER to finish the editing procedure.  
“EDITING” then “UTOCwriting” appears on the display while the editing you have made is being recorded on the MD.

## Erasing Tracks in a Group — ERASE GR

This function allows you to erase a group together with tracks in the group.

You cannot resume the tracks in the erased group. Once a group is erased, the other tracks and groups are renumbered.

- To stop any time during editing process, press MD TITLE INPUT/EDIT.

### On the remote control ONLY:

- 1 Insert an MD to edit.
- 2 Press MD TITLE INPUT/EDIT repeatedly while pressing MD GROUP to select “ERASE GR?”  
The source changes to “MD.”

- Each time you press MD TITLE INPUT/EDIT while pressing MD GROUP, the group editing mode changes as follows:

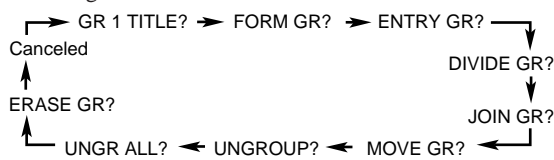

- If you want to stop this editing process, press CANCEL.

- 3 Press SET.

- 4 Press ►► or ◀◀ to select the group to be erased.

- **During playback:**  
The tracks in the selected group are played back repeatedly.

- 5 Press SET.  
“<ERASE GR>” appears on the display.
- To cancel the setting, press CANCEL, then repeat step 4.

- 6 Press ENTER to finish the editing procedure.  
“EDITING” then “UTOCwriting” appears on the display while the editing you have made is being recorded on the MD.

The buttons emphasized in the illustration below are used and explained in this section (pages 49 to 52.)

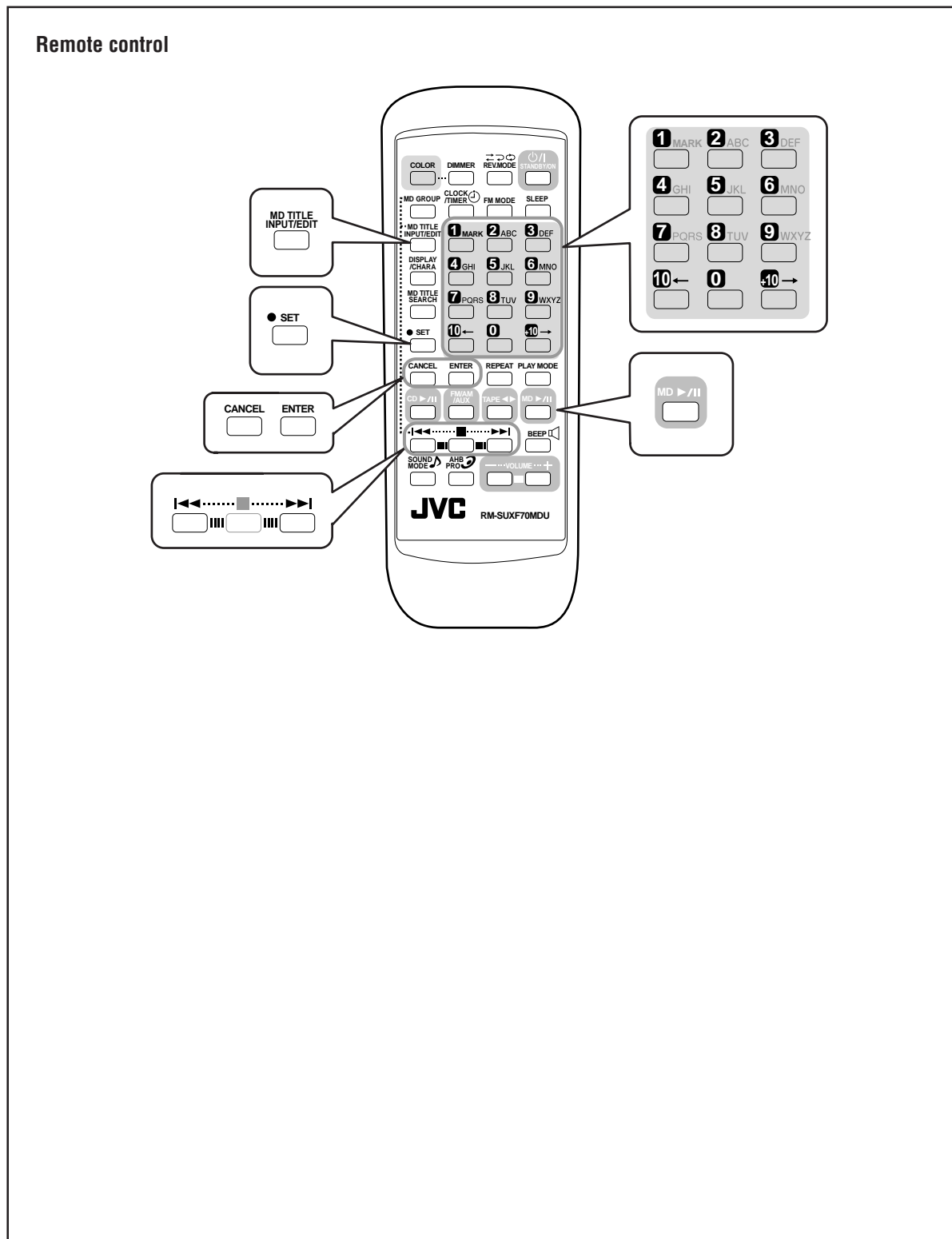

## Introducing MD Track Editing

MD tracks can be edited in many ways. The MD track editing includes the following functions.

### Dividing a track (DIVIDE) : Page 50

This function divides a track by adding a track marking(s) in the desired point(s) in the middle or where you want to search later.

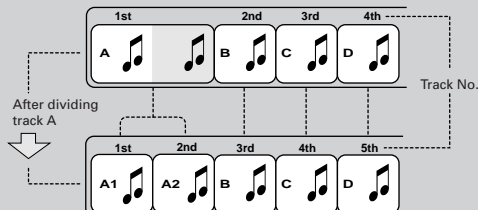

### Joining two tracks (JOIN) : Page 50

This function joins two adjacent tracks into a single track by deleting a track marking.

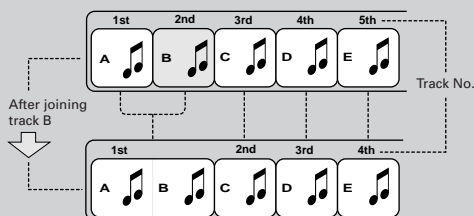

### Moving a track (MOVE) : Page 51

This function moves a track by reordering the track numbers.

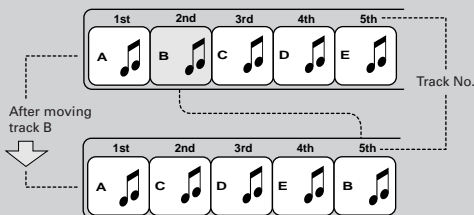

### Erasing tracks (ERASE) : Page 52

This function erases selected tracks. After the erasure, the subsequent tracks are justified and their track numbers are renumbered automatically. You can erase up to 15 tracks at a time.

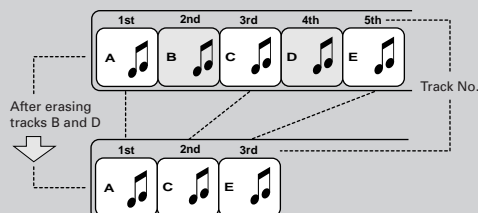

### Erasing all tracks (ALL ERASE) : Page 52

This function erases data in a disc entirely.

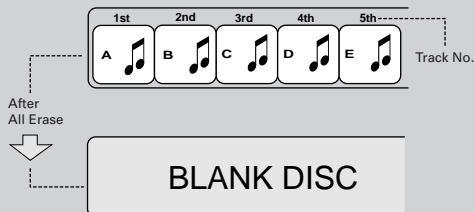

### Erasing a portion of a track

By combining "DIVIDE," "ERASE," and "JOIN," for example, it is possible to erase only a part of an existing track.

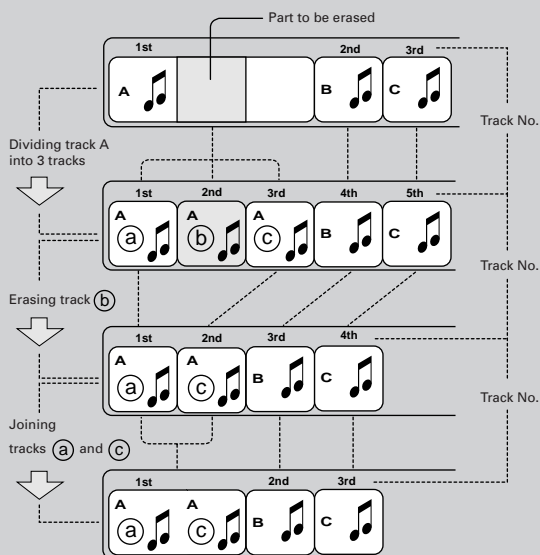

If "PLAYBACK DISC" or "DISC PROTECTED" appears on the display when you try to edit an MD You cannot edit such MDs (see page 30.)

## Dividing a Track — DIVIDE

This function allows you to divide one track into two separate tracks. It is useful, for example, when you want to add track marks at a certain point within a track or if you want to separate a recording.

When the original track has a title, two separate tracks are reassigned the same title as the original track.

Once a new track is divided, the other tracks are renumbered.

- To stop any time during editing process, press MD TITLE INPUT/EDIT.

### On the remote control ONLY:

**1** Insert an MD to edit.

**2** Press MD TITLE INPUT/EDIT repeatedly until “DIVIDE ?” appears on the display.

The source changes to “MD.”



- Each time you press MD TITLE INPUT/EDIT, the edit mode changes as follows:

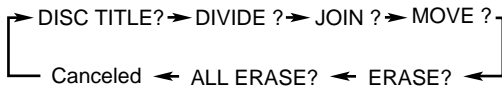

- If you want to stop this editing process, press CANCEL.

**3** Press SET.

The first track on the MD starts playback repeatedly.

- During playback:**  
The current track number starts playback repeatedly.

**4** Press ►► or ◀◀ to select a track you want to divide.

- You can select the track using number buttons. In this case, the selected track starts playback repeatedly.

- During playback:**  
The selected track starts playback repeatedly.

**5** Press SET when you find the point where you want to divide the track.

“POSIT. 0?” appears on the display, and the unit repeats the selected point — a 3-second period following the dividing point.

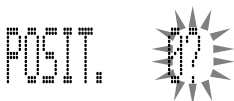

- If the dividing point is satisfactory, go to step 7.
- If not, go to the next step.
- To cancel the setting, press CANCEL, then repeat step 4.

**6** Press → or ← to adjust the dividing point precisely.

When you stop pressing the buttons, the unit repeats the newly selected dividing point.

- You can shift the dividing point up to ±128. This range (±128) corresponds to approximately ±8 seconds\* from the original point (Position 0).

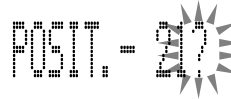

Ex. The dividing point is shifted to “- 21.”

\* When “SP” is selected for the recording length mode. For “LP2,” it is approximately ±16 seconds, and for “LP4” approximately ±32 seconds.

- When you find the right position, go to the next step.
- To cancel the setting, press CANCEL, then repeat step 4.

**7** Press SET.

“<DIVIDE>” appears on the display.

**8** Press ENTER to finish the editing procedure.

“EDITING” then “UTOCwriting” appears on the display while the editing you have made is being recorded on the MD.

To join the divided tracks, see the JOIN function below.

## Joining Two Tracks — JOIN

This function allows you to join two adjacent tracks into one track.

When the tracks have each title, the title of the preceding track is reassigned to the joined track.

Once two tracks are joined, the other tracks and/or the groups are renumbered.

- To stop any time during editing process, press MD TITLE INPUT/EDIT.

### On the remote control ONLY:

**1** Insert an MD to edit.

**2** Press MD TITLE INPUT/EDIT repeatedly until “JOIN ?” appears on the display.

The source changes to “MD.”



- Each time you press MD TITLE INPUT/EDIT, the edit mode changes as follows:

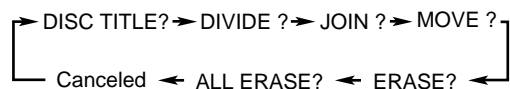

- If you want to stop this editing process, press CANCEL.

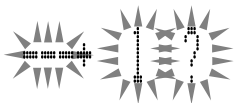

**3** Press SET.

- **During playback:**  
The current track number starts flashing.

**4** Press ►► or ◀◀ to select the two adjacent tracks you want to join.

- You can select the track using number buttons. In this case, the selected track starts playback repeatedly.

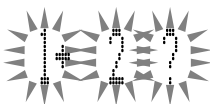

Ex. When you want to join tracks 1 and 2.

- **During playback:**  
The selected track starts playback repeatedly.

**5** Press SET.

- “<JOIN>” appears on the display.
- To cancel the setting, press CANCEL, then repeat step 4.

**6** Press ENTER to finish the editing procedure.

“EDITING” then “UTOCwriting” appears on the display while the editing you have made is being recorded on the MD.

To divide the joined tracks, see the DIVIDE function on page 50.



If “CANNOT JOIN” appears in step 5

You cannot join the following tracks.

- Tracks recorded using different recording length modes (SP, LP2, LP4) (see page 31.)
- Digital-recording tracks and analog-recording tracks.
- Tracks recorded using monaural long recording method (not possible on this unit) and stereo-recording tracks.



When the tracks belongs to a group

If the preceding track of two tracks you want to join belongs to a group, the newly joined track will belong to the same group; Otherwise, the joined track will not belong to any groups.

## Moving a Track — MOVE

This function allows you to move a track to the position you prefer. It is useful to change the order of the tracks as you like. Once a track is moved, the tracks and the other groups are renumbered.

- To stop any time during editing process, press MD TITLE INPUT/EDIT.

**On the remote control ONLY:**

**1** Insert an MD to edit.**2** Press MD TITLE INPUT/EDIT repeatedly until “MOVE ?” appears on the display.

The source changes to “MD.”



- Each time you press MD TITLE INPUT/EDIT, the edit mode changes as follows:

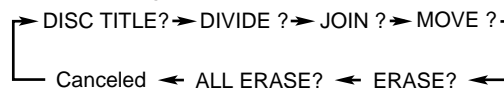

- If you want to stop this editing process, press CANCEL.

**3** Press SET.

- **During playback:**  
The current track number starts flashing.

**4** Press ►► or ◀◀ to select a track you want to move.

- You can select the track using number buttons. In this case, the selected track starts playback repeatedly.

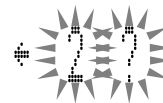

Ex. When you want to move track 2.

- **During playback:**  
The selected track starts playback repeatedly.

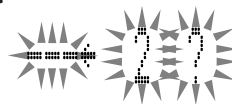
**5** Press SET.

- To cancel the setting, press CANCEL, then repeat step 4.

**6** Press ►► or ◀◀ to select the position where you want to move the track.

- You can select the track using number buttons. In this case, the selected track starts playback repeatedly.

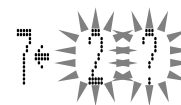

Ex. When you want to move track 2 to the position of track 7.

- **During playback:**  
The selected track starts playback repeatedly.
- To cancel the setting, press CANCEL, then repeat step 4.

**7** Press SET.

- “<MOVE>” appears on the display.
- To cancel the setting, press CANCEL, then repeat step 4.

**8** Press ENTER to finish the editing procedure.

“EDITING” then “UTOCwriting” appears on the display while the editing you have made is being recorded on the MD.



## Erasing Tracks — ERASE

This function allows you to erase an unwanted track. Once tracks are erased, the other tracks and/or groups are renumbered.

- To stop any time during editing process, press MD TITLE INPUT/EDIT.

### On the remote control ONLY:

**1** Insert an MD to edit.

**2** Press MD TITLE INPUT/EDIT repeatedly until “ERASE?” appears on the display. The source changes to “MD.”



- Each time you press MD TITLE INPUT/EDIT, the edit mode changes as follows:

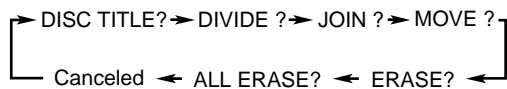

- If you want to stop this editing process, press CANCEL.

**3** Press SET.



- **During playback:**  
The current track number starts flashing.

**4** Select a track you want to erase.

1) Press ►► or ◀◀.

- You can select the track using number buttons. In this case, the selected track starts playback repeatedly.



Ex. Track 2 is selected.

- **During playback:**  
The selected track starts playback repeatedly.

2) Press SET.

**5** Repeat step 4 to select all the tracks you want to erase.

- To cancel, press CANCEL.

**6** Press ENTER.

“<ERASE>” appears on the display.

**7** Press ENTER again to finish the editing procedure.

“EDITING” then “UTOCwriting” appears on the display while the editing you have made is being recorded on the MD.

## Erasing All Tracks — ALL ERASE

This function allows you to erase all the tracks on an MD.

### On the remote control ONLY:

**1** Insert an MD to edit.

**2** Press MD TITLE INPUT/EDIT repeatedly until “ALL ERASE?” appears on the display. The source changes to “MD.”



- Each time you press MD TITLE INPUT/EDIT, the edit mode changes as follows:

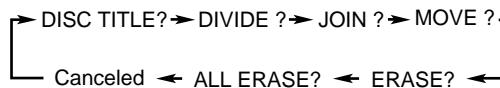

- If you want to stop this editing process, press CANCEL.

**3** Press SET.

“<ALL ERASE>” appears on the display.

- To cancel the setting, press MD TITLE INPUT/EDIT.

**4** Press ENTER to finish the editing procedure.

“EDITING” then “UTOCwriting” appears on the display while the editing you have made is being recorded on the MD.

- “BLANK DISC” appears on the display after all track an erased.



# Assigning Titles to an MD

The buttons emphasized in the illustration below are used and explained in this section (pages 54 and 55.)

## Remote control

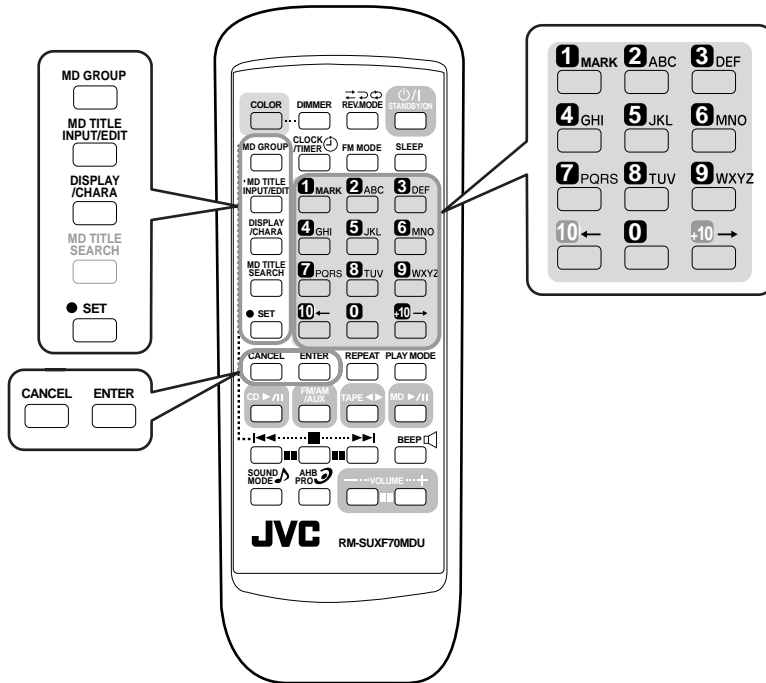

## Main unit (Top view)

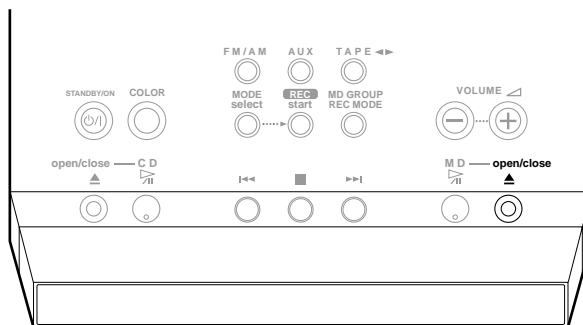

## Assigning the Disc Title, Track Title and Group Title

You can assign a name to each MD, to each track and to each group using alphabetic characters (uppercase and lowercase), symbols and numerals. Once a title is assigned, it is displayed for your confirmation.

### About the number of characters inputted for an MD

The total number of characters that can be input for an MD is 1792. The maximum number that can be input for a disc title is 64, and for each track, 61. (However, the actual number you can input may be slightly less than this maximum numbers due to the MD limitations — see page 63.)

- A space can be counted as one character.
- When the stereo long-hour recording (LP2 or LP4, see page 31) method is used for recording, the maximum number you can input for a track title automatically reduced since “LP:” and four spaces are automatically added to the beginning of the track title. Consequently this reduces the total number of characters you can input for an MD.
- You can input up to 10 characters for each track if an MD is composed of 120 tracks recorded using the stereo long-hour recording method.

In the following example, the process is explained from the very first — that is, inserting a disc. If you have already started recording or playing, start from step 2.

- To exit from the title entry screen any time during process, press MD TITLE INPUT/EDIT.

### 1 Insert an MD to edit.

### 2 Press MD TITLE INPUT/EDIT.

The source is changes to “MD.”

The MD recorder enters one of the following title entry screen.

- **Disc title entry screen:** appears when you press MD TITLE INPUT/EDIT while the MD recorder stops.

DISC TITLE?

- **Track title entry screen:** appears when you press MD TITLE INPUT/EDIT while playing, pausing or recording.

1 TITLE?

- **Group title entry screen:** appears when you press MD TITLE INPUT/EDIT while pressing MD GROUP.

GR 1 TITLE?

### 3 Press → or ← to change the title entry mode.

- **Disc title and track title entry screen:** Each time you press the button, the title entry mode changes as follows:

DISC TITLE? ↔ 1 TITLE? ↔ 2 TITLE?  
Last track ↔ ... ↔ 3 TITLE?

- **Group title entry screen:** Each time you press the button, the title entry mode changes as follows:

GR 1 TITLE? ↔ GR 2 TITLE?  
Last group ↔ ... ↔ GR 3 TITLE?

- “GR-- TITLE?” appears on the display when the current track is not included in any group.

### 4 Press SET to enter the selected title entry mode.

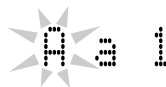
DISC   
A a 1 

Ex. When assigning a disc title.

### 5 Input a character.

- 1) Press DISPLAY/CHARA to select the character set you want.

- Each time you press the button, the character set is selected in sequence as follows:

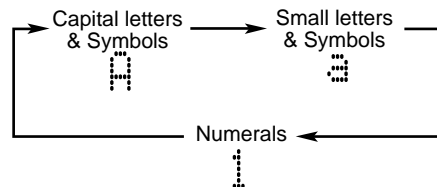

- 2) Press the character entry button for a character you want to input.

Ex.:

- To input an “A” or “a,” press ABC once.
- To input a “B” or “b,” press ABC twice.
- To input a “C” or “c,” press ABC three times.
- To input a symbol, press MARK repeatedly until the mark you want appears.
- To input a numeral, press 0 – 9.
- To enter a space while entering a title, press → twice.
- To move the character entry position while entering a title, press → or ←.
- If you have entered an incorrect character, press CANCEL to cancel the last entry.

### 3) Repeat steps 5–1) and 5–2) to input other characters.

- If the character you want to input next is assigned to the same button you have just pressed in step 5–2), press → first to move the character entry position to the right, then press the character entry button.
- The main display can only show 15 characters at a time. If you enter the 16th character, the first character disappears from the display, and so on.

## 6 Press ENTER to finish the current title entry.

After “EDITING” appears on the display for a while, the unit enters the next title entry mode (if any.)

EDITING

- You can assign another title by repeating steps 3 to 6.

## 7 Press MD open/close ▲ on the main unit to eject the MD.

“UTOCwriting” appears on the display while the editing you have made is being recorded on the MD.



You can assign titles during play or recording

#### • During play:

##### Entering a disc title

The MD recorder repeats playback of all tracks of the MD until you press ENTER in step 6 above. When you press ENTER, the MD recorder enters the track title entry mode.

##### Entering a track title

The MD recorder repeats playback of the current track until you press ENTER in step 6 above. When you press ENTER, the MD recorder enters the next track title entry mode.

##### Entering a group title

The MD recorder repeats playback of all the tracks of the current group until you press ENTER in step 6 above. When you press ENTER, the MD recorder enters the next group title entry mode.

#### • During recording:

##### Entering a disc title, track title and group title

The MD recorder continues recording even after you press ENTER in step 6 above. When you press ENTER, a title is assigned to the track or group where you have started the title entry. If you do not press ENTER before recording ends, the title assigned will be canceled. (When assigning titles to a disc or track, next title entry mode appears.)

You cannot assign group title if the MD has no group or “GROUP OFF” is selected.

#### • During CD Synchronized Recording (see page 32):

You can assign the disc title, and 16 track titles one after another as recording goes on. The track titles you have entered are automatically assigned to the tracks recorded on the MD in sequential order.



Available Symbols are as follows:

(Blank)	!	"	#	\$	%	&	'	( )
*	+	,	–	.	/	:	;	< =
>	?	@	_	\				

## Changing the Title

You can make a correction or change the title.

### 1 Follow steps 1 to 4 on page 54.

### 2 Press → or ← to select the character you want to correct.

- Make sure that the character you want to change is flashing.

### 3 Press CANCEL to delete the character you have selected in the above step.

### 4 Input the correct character, referring to step 5 on page 54 and this page.

### 5 Repeat steps 2 to 4 of the current procedure to correct more characters.

### 6 Press ENTER to finish correcting the title.

- If you want to correct another title, select another title entry mode by pressing → or ←, press SET, and then repeat from step 2 above.
- If you want to finish the correction, go to the next step.

### 7 Press MD open/close ▲ on the main unit to eject the MD.

“UTOCwriting” appears on the display while the editing you have made is being recorded on the MD.

#### To erase all the characters

Press CANCEL repeatedly in step 3 above to erase all the characters, then go to step 6 and 7.

The buttons emphasized in the illustration below are used and explained in this section (pages 57 to 60.)

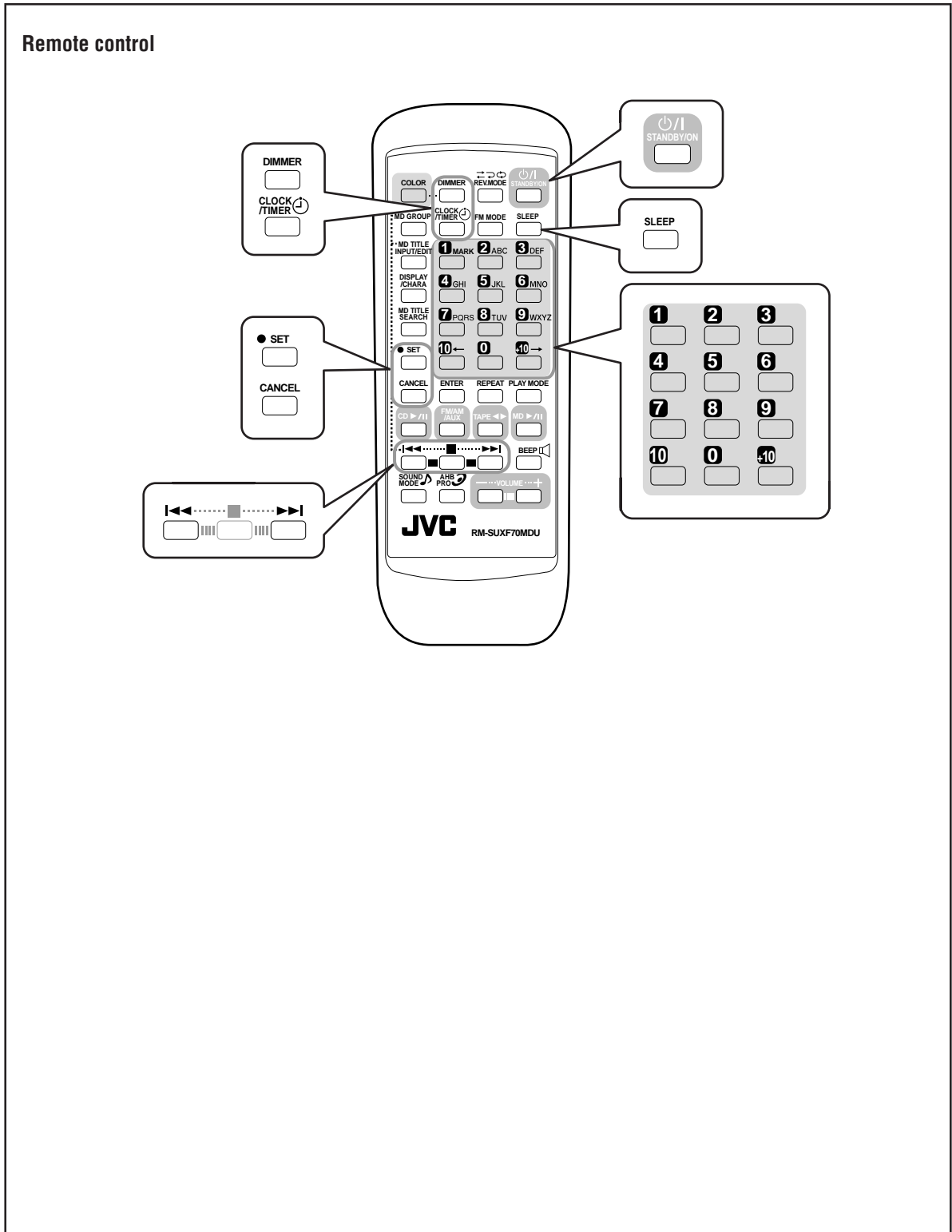

There are three timers available — Recording Timer, Daily Timer, and Sleep Timer.

**Before using these timers, you need to set the built-in clock.**

## Setting the Clock

You can set the clock whether the unit is turned on or off (on standby.)

**On the remote control ONLY:**

- 1 Press **CLOCK/TIMER** repeatedly until “**TIME ADJUST**” appears on the display.  
The hour digit flashing on the display.



- 2 Press **▶▶** or **◀◀** repeatedly to adjust the hour.
  - When press and hold the button, the hour digit changes continuously.

- 3 Press **SET** to set the hour.  
The minute digit starts flashing on the display.



Ex. When pressing SET after adjusting the hour to 10.

- If you want to correct the hour again, press **CANCEL**.  
The hour digit starts flashing again.
- 4 Press **▶▶** or **◀◀** repeatedly to adjust the minute.
    - When press and hold the button, the minute digit changes continuously.

- 5 Press **SET** to finish setting the clock.  
The built-in clock starts.



Ex. When pressing SET after adjusting the minute to 10.



**To adjust the clock again**

Press **CLOCK/TIMER** repeatedly in step 1 until “**TIME ADJUST**” appears on the display, then perform steps 2 to 5 above.



**When you unplug the AC power cord or if a power failure occurs**

The clock setting will be reset to “0:00.” If this happen, you need to set the clock again.



**To check the clock time by sound while the unit is turned off (on standby)**

Press **DIMMER** while the key-touch tone is set to on. The clock time will be indicated by sound.

## Using Recording Timer

With Recording Timer, you can make an unattended recording.

- You can set Recording Timer whether the unit is turned on or off (on standby.)
- To correct a mis-entry any time during the setting process, press **CANCEL**.

### How Recording Timer actually works

The unit automatically turns on, and starts recording on an MD or a tape when the timer-on time comes. Then, when the timer-off time comes, the recording stops and the unit automatically turns off (on standby).

Recording Timer works only once, but the timer settings remain stored in memory until you reset them or unplug the AC power cord.

**On the remote control ONLY:**

- 1 Press **CLOCK/TIMER** repeatedly until “**REC TIMER**” appears on the display.  
The timer (⌚) indicator lights, and the REC indicator starts flashing on the display.
  - Each time you press the button, the timer mode changes as follows:

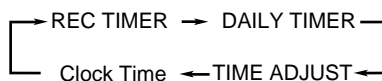

- 2 Press **◀◀** to select “**ON,**” then press **SET**.

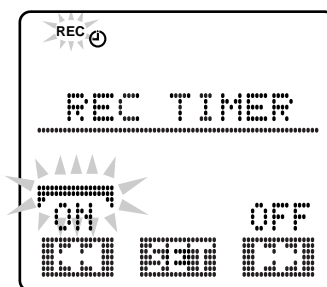

- 3 Select the source to record.

- 1) Press **▶▶** or **◀◀** repeatedly to select the source.
  - Each time you press the buttons, the source changes as follows:

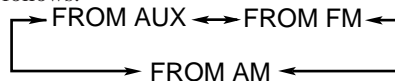

- 2) Press **SET**.
  - When you select “**FROM FM**” or “**FROM AM,**” select a preset number by pressing **▶▶** or **◀◀**.
  - When you select “**FROM AUX,**” the external equipment also need to have the timer function.

- 3) Press **SET** again.

#### 4 Select the media to be recorded on.

- 1) Press ►►| or |◀◀ repeatedly to select the media.

TO MD ◀◀ TO TAPE

- 2) Press SET.

- When you select “TO MD,” select the recording length mode from “SP,” “LP2,” or “LP4” by pressing ►►| or |◀◀.
- When you select “TO TAPE,” select the reverse mode either ◀▶ or ▶◀ by pressing ►►| or |◀◀.

- 3) Press SET again.

#### 5 Set the timer-on and timer-off time.

- 1) Press ►►| or |◀◀ repeatedly to select the hour of the timer-on time, then press SET.

The minute digit of timer-on time starts flashing on the display.



- 2) Press ►►| or |◀◀ repeatedly to select the minute of the timer-on time, then press SET.

The hour digit of timer-off time starts flashing on the display.



- 3) Press ►►| or |◀◀ repeatedly to select the hour of the timer-off time, then press SET.

The minute digit of timer-off time starts flashing on the display.



- 4) Press ►►| or |◀◀ repeatedly to select the minute of the timer-off time, then press SET.

The REC indicator stops flashing and remains lit.

#### 6 Press ○/I STANDBY/ON to turn off the unit (on standby) if necessary.

The setting you have done are shown on the display in sequence.

The REC indicator remains lit on the display.

- No sounds come out of the speaker during timer recording is performed.

#### To turn off the Recording Timer after its setting is done,

- 1 Press CLOCK/TIMER repeatedly until “REC TIMER” appears on the display.
- 2 Press ►►| to select “OFF” in step 2 on page 57. The timer (⌚) and REC indicators go off from the display.

To turn on the Recording Timer again, press |◀◀ to select “ON” in step 2 above.

The timer (⌚) and REC indicators light on the display. The settings you have done are shown on the display for your confirmation.



**Recording Timer will be canceled and the unit will not turn off automatically in the following.**

- When you press ■ (while recording.)
- When you turn off the Recording Timer (see above.)



**When you unplug the AC power cord or if a power failure occurs**

The clock setting, the tuner preset stations and other settings will be erased.

## Using Daily Timer

With Daily Timer, you can wake up to your favorite music or radio program.

- You can set Daily Timer whether the unit is turned on or off (on standby.)
- To correct a mis-entry any time during the setting process, press CANCEL.

### How Daily Timer actually works

The unit automatically turns on, and starts playing the specified source when the timer-on time comes. Then, when the timer-off time comes, the unit automatically turns off (on standby).

Daily Timer works every day, and the timer settings remain stored in memory until you reset them or unplug the AC power cord.

#### On the remote control ONLY:

#### 1 Press CLOCK/TIMER repeatedly until “DAILY TIMER” appears on the display.

The timer (⌚) indicator lights, and the DAILY indicator starts flashing on the display.

- Each time you press the button, the timer mode changes as follows:

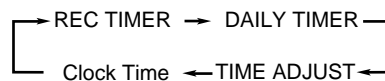

- 2** Press **◀◀** to select “ON,” then press SET.

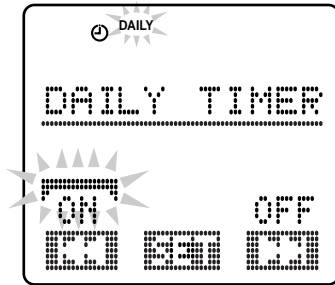

- 3** Select the source to play.

- 1) Press **▶▶** or **◀◀** repeatedly to select the source.
- Each time you press the buttons, the source changes as follows:

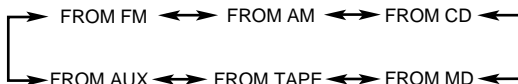

- 2) Press SET.
- When you select “FROM FM” or “FROM AM,” select a preset number by pressing **▶▶** or **◀◀**.
  - When you select “FROM AUX,” the external equipment also need to have the timer function.
- 3) Press SET again.

- 4** Set the timer-on and timer-off time.

- 1) Press **▶▶** or **◀◀** repeatedly to select the hour of the timer-on time, then press SET.

The minute digit of timer-on time starts flashing on the display.



- 2) Press **▶▶** or **◀◀** repeatedly to select the minute of the timer-on time, then press SET.

The hour digit of timer-off time starts flashing on the display.



- 3) Press **▶▶** or **◀◀** repeatedly to select the hour of the timer-off time, then press SET.

The minute digit of timer-off time starts flashing on the display.



- 4) Press **▶▶** or **◀◀** repeatedly to select the minute of the timer-off time, then press SET.

- 5** Adjust the volume level.

- 1) Press **▶▶** or **◀◀** repeatedly to adjust the volume level.

- You can adjust the volume level within the range of 0 (silent) to 40 (maximum.)
- When you select “VOLUME --,” the volume is set to the current volume level.

- 2) Press SET.

The setting you have done are shown on the display in sequence.

The DAILY indicators stop flashing and remains lit on the display.

- 6** Press **⏻** STANDBY/ON to turn off the unit (on standby.)

To turn off the Daily Timer after its setting is done,

- 1) Press CLOCK/TIMER repeatedly until “DAILY TIMER” appears on the display.

- 2) Press **▶▶** to select “OFF” in step 2.

The timer (⌚) and DAILY indicators go off from the display.

To turn on the Daily Timer again, press **◀◀** to select “ON” in step 2 above.

The timer (⌚) and DAILY indicators light on the display.

The settings you have done are shown on the display for your confirmation.



**notes** If the unit is kept turned on when the timer-on time comes

Daily Timer does not work at all.



**notes** Daily Timer will be canceled and the unit will not turn off automatically in the following.

- When you change the source.
- When you turn off the Daily Timer (see above.)



**notes** When you unplug the AC power cord or if a power failure occurs

The clock setting, the tuner preset stations and other settings will be erased.



## Using Sleep Timer

With Sleep Timer, you can fall asleep to your favorite music.

- You can set Sleep Timer when the unit is turned on.

### How Sleep Timer actually works

The unit automatically turns off after the specified time length passes.

#### On the remote control ONLY:

- Press SLEEP repeatedly until the time length you want appears on the display.

The timer (⌚) indicator starts flashing and "SLEEP 10" appears on the display.

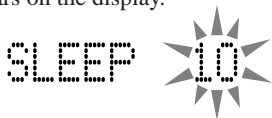

- Each time you press the button, the time length changes as follows:

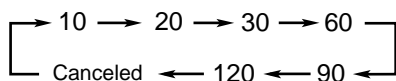

- Press SET or wait for about 5 seconds.

The display illumination dim.

"SLEEP" appears on the display.

**To check the remaining time until the shut-off time,** press SLEEP once. The remaining time until the shut-off time appears for about 5 seconds.

**To change the shut-off time,** press SLEEP repeatedly until the time length you want appears.

**To cancel the setting,** press SLEEP repeatedly until "SLEEP" disappears from the display.



**Sleep Timer will be canceled in the following.**

- When you turn off the unit.
- When you operate other timer settings.
- When you adjust the clock.



**If "CLOCK ADJUST" appears on the display**

You need to set the built-in clock (see page 57.)

## To sleep with the Sleep Timer and wake up with the Daily Timer

The unit turns off when the shut-off time comes (set by the Sleep Timer), and turns on when the timer-on time comes (set by the Daily Timer).

- Set the Daily Timer as explained on pages 58 and 59.
- Start playing back any source you want to listen to before sleep.
- Set the Sleep Timer.

## Timer Priority

Since each timer can be set separately, you may wonder what happens if the setting for these timers overlaps. Here are the priorities for each timer.

- A timer with the late timer-on time has priority.**

If Recording Timer is set to come on while Daily Timer is operating, Daily Timer is canceled.

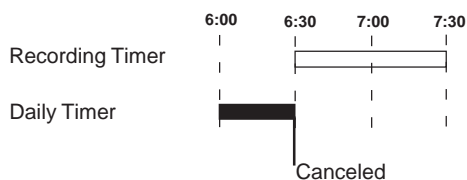

If Recording Timer is set to come on while Sleep Timer is operating, Sleep Timer will not shut off the power even if the shut-off time comes.

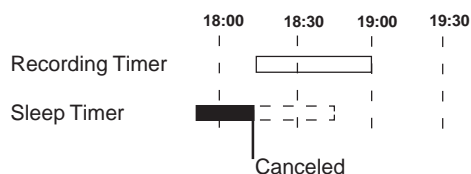

# Maintenance

To get the best performance of the unit, keep your discs, tapes, and mechanism clean.

## General Notes

In general, you will have the best performance by keeping your discs and the mechanism clean.

- Store discs in their cases, and keep them in cabinets or on shelves.
- Keep the electronic swing panel closed when not in use.

## Cleaning the unit

### • Stains on the unit

Should be wiped off with a soft cloth. If the unit is heavily stained, wipe it with a cloth soaked in water-diluted neutral detergent and wrung well, then wipe clean with a dry cloth.

### • Avoid the following since they may cause damage to the unit.

- DO NOT wipe it with a hard cloth.
- DO NOT wipe it strong.
- DO NOT wipe it with thinner or benzine.
- DO NOT apply any volatile substance such as insecticides to it.
- DO NOT allow any rubber or plastic to remain in contact with it for a long time.

## Handling discs



- Remove the disc from its case by holding it at the edge while pressing the center hole lightly.
- Do not touch the shiny surface of the disc, or bend the disc.
- Put the disc back in its case after use to prevent warping.

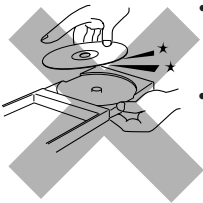

- Be careful not to scratch the surface of the disc when placing it back in its case.
- Avoid exposure to direct sunlight, temperature extremes and moisture.

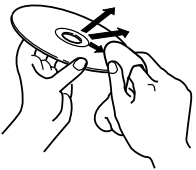

### To clean the disc

Wipe the disc with a soft cloth in a straight line from center to edge.

## Handling MDs

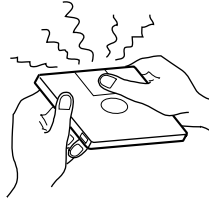

- Do not open the shutter.
  - The shutter is locked so that it will not open. Trying to force it open will break the MD. If the shutter opens accidentally, close it again quickly without touching the MD inside.

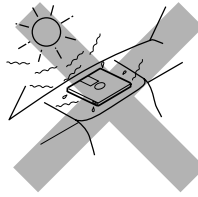

- Do not place MDs in the following places:
  - High temperature areas such as in direct sunlight or inside a car.
  - High humidity areas such as in a bathroom.
  - On a beach or sandy area.

### • Clean MDs regularly.

- If dust or dirt gets on cartridge, wipe it off with a soft dry cloth.

## Handling cassette tapes

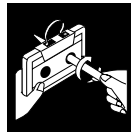

- If the tape is loose in its cassette, take up the slack by inserting a pencil in one of the reels and rotating.
- If the tape is loose, it may get stretched, cut, or caught in the cassette.



- Be careful not to touch the tape surface.



- Avoid the following places to store the tape:
  - In dusty places
  - In direct sunlight or heat
  - In moist areas
  - On a TV or speaker
  - Near a magnet



DO NOT use any solvent — such as conventional record cleaner, spray, thinner, or benzine — to clean the disc.

## MD Disc Types

There are two types of MDs: Premastered (prerecorded) and Recordable (blank).

### Premastered MDs

Premastered MDs, which have been recorded at music studio, can be played back like regular CDs. On an MD of this type, data is recorded as the presence or absence of tiny pits. A laser beam focuses on the pits on the surface of the MD and reflects the detection back to the lens in the MD recorder. The MD recorder then decodes the signals and plays them back as music. This type of MD is called an “optical disc.”

### Recordable MDs

Recordable MDs, which use magneto-optical technology, can be recorded and played back repeatedly. The laser inside the MD recorder applies heat to the MD, demagnetizing the magnetic layer of the MD for recording and playback. This type of MD is called an “magnetic-optical disc.”

## ATRAC (Adaptive TRansform Acoustic Coding)/ATRAC3 (MDLP)

The MD provides 80 minute recording and playback time, much more than an audio CD, but in a diameter of only 64 mm. This ability to store such a large amount of data is the result of ATRAC, an audio compression technique developed for MD. This technology cuts out faint sounds that would not be heard by the human beings. This technology, based on human sensitivity to sounds, reduces recorded data volume up to about one-fifth of the original data volume.

Furthermore, this unit takes advantage of the latest ATRAC3 techniques, which can reduce the amount of data to record to one-10th or one-20th of the original data volume. This allows for 2 times or 4 times long-hour stereo recording on this unit.

## UTOC (User Table Of Contents)

Found only on recordable MDs, this area contains sub-data (track number, recording data, etc.) which can be rewritten by the user.

UTOC enables us to search tracks quickly and edit tracks on the MD.

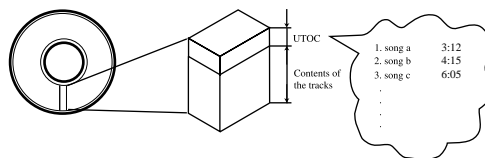

## Sound Skip Guard Memory

The biggest weakness of discs is their susceptibility to vibration. The “Sound Skip Guard Memory” has been developed to cope with this weakness.

With this function, a few seconds of signals read by the optical read head from the MD are first stored in memory before being reproduced as audio signals. Thus, even when vibration or shock interrupts signals being read, these stored signals can continue to reproduce sounds for the few seconds. Thus, the user will enjoy uninterrupted music.

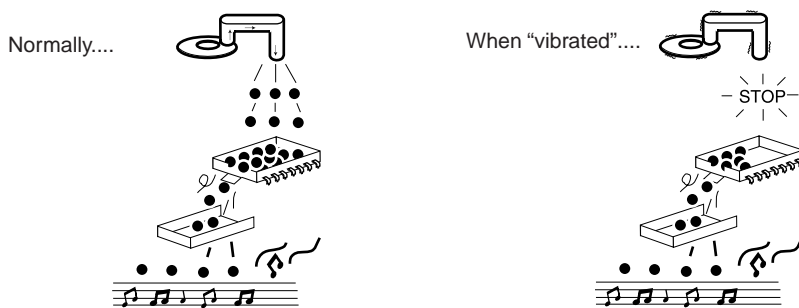

## SCMS (Serial Copy Management System)

The MD recorder integrated to this unit uses the Serial Copy Management System which allows only first-generation digital copies to be made of premastered software (like CDs or prerecorded MDs.)

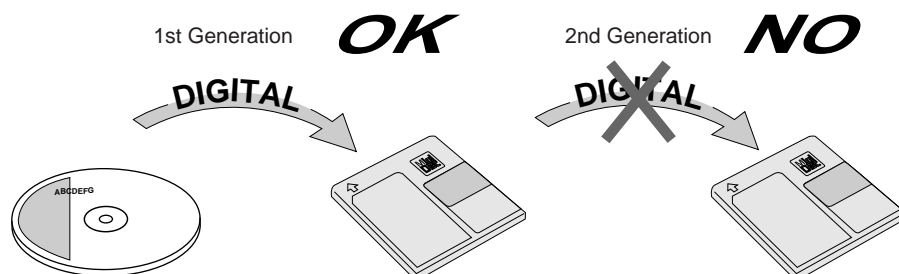

## HCMS (High-speed Copy Management System)

Now onto recordable MDs (minidiscs), you can record (copy) sound at a recording speed exceeding the normal speed. This fact requires some restrictions for protecting copyrights.

On this unit, you cannot re-record, at either high speed or normal speed, a song (track) that has been recorded once from a CD at high speed, until 74 minutes elapse after the first recording of the song started.

For example, after having recorded the first song (track) of a CD at high speed, you cannot record it again, at either high speed or normal speed, until 74 minutes elapse after the first recording of that song started.

### MD limitations

The MD records data in an original format that differs from that of conventional cassette tapes or DATs (Digital Audio Tape.) Since there are some limitations with this recording format, the following types of symptoms may occur. These symptoms are not malfunctions.

Symptoms	Cause
"DISC FULL" appears, even though there is still enough remaining time on an MD.	There is a maximum number of tracks which can be recorded, regardless of recording time. More than 254 tracks cannot be recorded on an MD.
"DISC FULL" appears, even though the number of tracks and recording time do not reach the limit.	Repeating erasure and recording on the same MD creates many blank portions sparsely on the MD. When recording on such an MD, a track is recorded on these blank portions sparsely. If a track is divided and recorded into so many portions, "DISC FULL" appears.
The JOIN function sometimes does not work.	If a divided portion of less than 8 seconds is made while a track is recorded on the MD, that track cannot be joined to another track using the JOIN function. Furthermore, if that track is erased, the remaining time of the MD may not increase exactly by the erased amount.
The remaining time on the MD does not increase even when tracks are erased.	
The sound drops out during fast forward or fast reverse.	If a track has been divided into many portions while being recorded on the MD, sounds will drop out while fast forwarding or reversing such an MD.
The amount of recorded time on the MD added to the amount of remaining time is shorter than the MD's total possible recording time.	You cannot record on a blank portion of less than 2 seconds in the MD. For this reason, the actual recording time of discs may become shorter.

Message	Signification	Solution
BLANK DISC	The disc is blank.	Change the MD with another if you want to enjoy playback.
CANNOT ENTRY!	The track has already been in the same group.	This is not a malfunction. (See “ENTRY GR” on page 44.)
CANNOT FORM!	You are trying to form a new group including group(s).	This is not a malfunction. (See “FORM GR” on page 43.)
CANNOT GROUP!	There is no more space for MD group information.	This is not a malfunction. (See “MD limitations” on page 63.)
CANNOT JOIN	You are trying to join tracks which cannot be joined.	This is not a malfunction. (See “JOIN GR” on page 45.)
CANNOT LISTEN!	You are trying to listen to the sound during high-speed recording.	This is not a malfunction. You cannot listen to the sound during high-speed recording.
CANNOT TITLE	You are trying to enter the title on the MD over 1792 characters in totals.	This is not a malfunction. (See “Assigning the Disc Title, Track Title and Group Title” on page 54.)
CD PROGRAM CANNOT X4 RECORDING!	You are trying to record a CD in program play mode using x4 speed-recording.	This is not a malfunction. You cannot record a CD in program play mode using x4 speed-recording.
CD RANDOM CANNOT X4 RECORDING!	You are trying to record a CD in random play mode using x4 speed-recording.	This is not a malfunction. You cannot record a CD in random play mode using x4 speed-recording.
DISC ERROR	There is a problem with the MD.	Change the MD.
DISC FULL	There is no more space on the MD or there are over 254 tracks.	Use another recordable MD or erase some tracks.
DISC PROTECTED	MD is write-protected.	Unprotect the MD or use another. (See page 30.)
EMERGENCY STOP	A malfunction has occurred during recording.	Stop playback, and eject the MD and re-insert it.
GROUP FULL	You are trying to form the group over 99 groups.	This is not a malfunction. There can be up to 99 groups on an MD at the same time.
GROUP TRACK	The track has already been in another group.	This is not a malfunction. (See “FORM GR” on page 43.)
HCMS CANNOT COPY	You are trying to re-record a song that has been recorded once at high speed, before 74 minutes have passed after its first recording.	An internal timer works to protect copyrights. Wait for 74 minutes or more, then start recording. (See “HCMS” on page 63.)
LOAD ERROR	MD is not loaded correctly.	Eject the MD and re-insert it.
MD NO DISC	There is no MD.	Put an MD.
NON AUDIO CANNOT COPY	You are trying to copy a non-audio disc like a CD-ROM, Video CD, or DVD.	Stop recording.
PLAYBACK DISC	You are trying to edit or record on a playback-only MD.	Use a recordable MD.

Message	Signification	Solution
SCMS CANNOT COPY	Digital copy of the 2nd generation is prohibited.	Use the external equipment connected to the LINE IN jacks (as the recording/playback device.)
TRACK PROTECTED	The track has been protected.	This unit can not unprotect it. To unprotect it, use the equipment with which it was protected.
X4 SPEED CANNOT COPY LOW TEMP	The room temperature is too low to record using x4 speed-recording.	This is not a malfunction. You can record using x4 speed-recording within 5°C – 35°C.
CANNOT PLAY	You are trying to play back a CD which cannot be played or there is a problem with the CD.	Change the CD.
CD LOAD ERROR	The CD tray does not open correctly because of the obstruction.	Press CD open/close ▲ to close the CD tray, then remove the obstruction.
UNFINALIZE	You are trying to play back a CD-R/RW which has not been 'finalized' yet.	This is not a malfunction. You can play back the 'finalized' CD-R/RW.

## Troubleshooting

If you are having a problem with your unit, check this list for a possible solution before calling for service.

If you cannot solve the problem from the hints given here, or the unit has been physically damaged, call a qualified person, such as your dealer, for service.

Symptom	Possible Cause	Action
No sound is heard.	Connections are incorrect or loose.	Check all connections and make corrections. (See pages 6 – 9.)
Unable to operate the remote control.	<ul style="list-style-type: none"> <li>The path between the remote control and the remote sensor on the unit is blocked.</li> <li>The batteries have lost their charge.</li> <li>You are using the remote control far from the unit.</li> </ul>	<ul style="list-style-type: none"> <li>Remove the obstruction.</li> <li>Replace the batteries. (See page 9.)</li> <li>Signals cannot reach the remote sensor. Move close to the unit.</li> </ul>
Unable to record on an MD.	<ul style="list-style-type: none"> <li>You are using a prerecorded MD.</li> <li>The MD is write-protected.</li> </ul>	<ul style="list-style-type: none"> <li>Use a recordable MD.</li> <li>Unprotect the MD. (See page 30.)</li> </ul>
Poor radio reception.	<ul style="list-style-type: none"> <li>The antenna is not connected correctly.</li> <li>The AM loop antenna is too close to the unit.</li> <li>The FM antenna is not properly extended and positioned.</li> </ul>	<ul style="list-style-type: none"> <li>Reconnect the antenna securely.</li> <li>Change the position and direction of the AM loop antenna.</li> <li>Extend FM antenna to the best reception position.</li> </ul>
Loaded CD and MD can not be ejected.	The main AC power cord is not plugged in.	Plug it in the AC power plug.
The CD does not play.	The CD is upside down.	Put the CD in with the label side up.
The disc skips.	The disc is dirty or scratched.	Clean or replace the disc. (See page 61.)
The cassette holder does not open or close.	Power supply from the AC power cord has been cut off while the tape was running.	Turn on the unit.
Impossible to record on a tape.	Small tabs on the back of the cassette are removed.	Cover the holes with adhesive tape.
Operations are disabled.	The built-in microprocessor has malfunctioned due to external electrical interference.	Unplug the unit then plug it back in.

# Specifications

## Amplifier

Output Power (IEC 268-3/DIN):

32 W (16 W + 16 W) at 4  $\Omega$  (MAX.)

30 W (15 W + 15 W) at 4  $\Omega$  (10 % THD)

Audio input sensitivity/Impedance (at 1 kHz)

LINE IN (AUX): 500 mV/47 k $\Omega$

Speaker Terminals: 4  $\Omega$  — 16  $\Omega$

## Tuner

FM tuning range:

87.50 MHz — 108.00 MHz

AM tuning range:

531 kHz — 1 710 kHz (at 9 kHz channel spacing)

530 kHz — 1 710 kHz (at 10 kHz channel spacing)

## CD player

CD Capacity: 1 CD

Dynamic range: 85 dB

Signal-to-noise ratio: 90 dB

Wow and flutter: Immeasurable

## MD recorder

Audio playing system: MiniDisc digital audio system

Recording system: Magneto-optical overwrite system

Reading system: Non-contact, semiconductor laser pickup ( $\lambda=780$  nm)

Error correction system: CIRC (Cross Interleave Reed-Solomon Code)

Recording/Playback time (when using a 80-minute MD):

SP : 80 minutes

LP2 : 160 minutes

LP4 : 320 minutes

Sampling frequency: 44.1 kHz

Audio compression system:

ATRAC (Adaptive TRansform

Acoustic Coding)/ATRAC3

(**MDLP**)

## Cassette deck

Frequency response

Normal (type I): 60 Hz — 14 000 Hz

Wow and flutter

0.15 % (WRMS)

## Speaker Section

Speakers: Woofer 10 cm, Tweeter 4 cm

Impedance: 4  $\Omega$

Dimensions (approx.):

140 mm x 200 mm x 249 mm (W/H/D)

(5 $\frac{1}{2}$  in. x 7 $\frac{7}{8}$  in. x 9 $\frac{7}{8}$  in.)

Mass (approx.): 2.0 kg (4.5 lbs)

## General

Power requirement: AC 230V  $\sim$  50 Hz

Power consumption: 51 W (at operation)

1.2 W (on standby)

Dimensions (approx.):

455 mm x 203 mm x 330 mm (W/H/D)

(18 in. x 8 in. x 13 in.)

Mass (approx.): 9 kg (19.9 lbs)

## Supplied accessories

See page 6.

US and foreign patents licensed from Dolby Laboratories Licensing Corporation.

Design and specifications are subject to change without notice.

